

Diagnosis Tester

Intelligent Tester II

Operator's Manual



EULA Terms

- You have acquired a device ("DEVICE") that includes software licensed by DENSO CORPORATION from an affiliate of Microsoft Corporation ("MS"). Those installed software products of MS origin, as well as associated media, printed materials, and "online" or electronic documentation ("SOFTWARE") are protected by international intellectual property laws and treaties. Manufacturer, MS and its suppliers (including Microsoft Corporation) own the title, copyright, and other intellectual property rights in the SOFTWARE. The SOFTWARE is licensed, not sold. All rights reserved.
- This EULA is valid and grants the end-user rights ONLY if the SOFTWARE is genuine and a genuine Certificate of Authenticity for the SOFTWARE is included. For more information on identifying whether your software is genuine, please see <http://www.microsoft.com/piracy/howtotell>.
- IF YOU DO NOT AGREE TO THIS END USER LICENSE AGREEMENT ("EULA"), DO NOT USE THE DEVICE OR COPY THE SOFTWARE. INSTEAD, PROMPTLY CONTACT DENSO CORPORATION FOR INSTRUCTIONS ON RETURN OF THE UNUSED DEVICE(S) FOR A REFUND. ANY USE OF THE SOFTWARE, INCLUDING BUT NOT LIMITED TO USE ON THE DEVICE, WILL CONSTITUTE YOUR AGREEMENT TO THIS EULA (OR RATIFICATION OF ANY PREVIOUS CONSENT).
- GRANT OF SOFTWARE LICENSE. This EULA grants you the following license:
 - You may use the SOFTWARE only on the DEVICE.
 - Restricted Functionality. You are licensed to use the SOFTWARE to provide only the limited functionality (specific tasks or processes) for which the DEVICE has been designed and marketed by DENSO CORPORATION. This license specifically prohibits any other use of the software programs or functions, or inclusion of additional software programs or functions that do not directly support the limited functionality on the DEVICE. Notwithstanding the foregoing, you may install or enable on a DEVICE, systems utilities, resource management or similar software solely for the purpose of administration, performance enhancement and/or preventive maintenance of the DEVICE.
 - If you use the DEVICE to access or utilize the services or functionality of Microsoft Windows Server products (such as Microsoft Windows Server 2003), or use the DEVICE to permit workstation or computing devices to access or utilize the services or functionality of Microsoft Windows Server products, you may be required to obtain a Client Access License for the DEVICE and/or each such workstation or computing device. Please refer to the end user license agreement for your Microsoft Windows Server product for additional information.
 - NOT FAULT TOLERANT. THE SOFTWARE IS NOT FAULT TOLERANT. DENSO CORPORATION HAS INDEPENDENTLY DETERMINED HOW TO USE THE SOFTWARE IN THE DEVICE, AND MS HAS RELIED UPON DENSO CORPORATION TO CONDUCT SUFFICIENT TESTING TO DETERMINE THAT THE SOFTWARE IS SUITABLE FOR SUCH USE.
 - NO WARRANTIES FOR THE SOFTWARE. THE SOFTWARE is provided "AS IS" and with all faults. THE ENTIRE RISK AS TO SATISFACTORY QUALITY, PERFORMANCE, ACCURACY, AND EFFORT (INCLUDING LACK OF NEGLIGENCE) IS WITH YOU. ALSO, THERE IS NO WARRANTY AGAINST INTERFERENCE WITH YOUR ENJOYMENT OF THE SOFTWARE OR AGAINST INFRINGEMENT. IF YOU HAVE RECEIVED ANY WARRANTIES REGARDING THE DEVICE OR THE SOFTWARE, THOSE WARRANTIES DO NOT ORIGINATE FROM, AND ARE NOT BINDING ON, MS.
 - No Liability for Certain Damages. EXCEPT AS PROHIBITED BY LAW, MS SHALL HAVE NO LIABILITY FOR ANY INDIRECT, SPECIAL, CONSEQUENTIAL OR INCIDENTAL DAMAGES ARISING FROM OR IN CONNECTION WITH THE USE OR PERFORMANCE OF THE SOFTWARE. THIS LIMITATION SHALL APPLY EVEN IF ANY REMEDY FAILS OF ITS ESSENTIAL PURPOSE. IN NO EVENT SHALL MS BE LIABLE FOR ANY AMOUNT IN EXCESS OF U.S. TWO HUNDRED FIFTY DOLLARS (U.S.\$250.00).
 - Restricted Uses. The SOFTWARE is not designed or intended for use or resale in hazardous environments requiring fail-safe performance, such as in the operation of nuclear facilities, aircraft navigation or communication systems, air traffic control, or other devices or systems in which a malfunction of the SOFTWARE would result in foreseeable risk of injury or death to the operator of the device or system, or to others.
 - Limitations on Reverse Engineering, Decompilation, and Disassembly. You may not reverse engineer, decompile, or disassemble the SOFTWARE, except and only to the extent that such activity is expressly permitted by applicable law notwithstanding this limitation.

- SOFTWARE as a Component of the DEVICE - Transfer. This license may not be shared, transferred to or used concurrently on different computers. The SOFTWARE is licensed with the DEVICE as a single integrated product and may only be used with the DEVICE. If the SOFTWARE is not accompanied by a DEVICE, you may not use the SOFTWARE. You may permanently transfer all of your rights under this EULA only as part of a permanent sale or transfer of the DEVICE, provided you retain no copies of the SOFTWARE. If the SOFTWARE is an upgrade, any transfer must also include all prior versions of the SOFTWARE. This transfer must also include the Certificate of Authenticity label. The transfer may not be an indirect transfer, such as a consignment. Prior to the transfer, the end user receiving the SOFTWARE must agree to all the EULA terms.
- Consent to Use of Data. You agree that MS, Microsoft Corporation and their affiliates may collect and use technical information gathered in any manner as part of product support services related to the SOFTWARE. MS, Microsoft Corporation and their affiliates may use this information solely to improve their products or to provide customized services or technologies to you. MS, Microsoft Corporation and their affiliates may disclose this information to others, but not in a form that personally identifies you.
- Internet Gaming/Update Features. If the SOFTWARE provides, and you choose to utilize, the Internet gaming or update features within the SOFTWARE, it is necessary to use certain computer system, hardware, and software information to implement the features. By using these features, you explicitly authorize MS, Microsoft Corporation and/or their designated agent to use this information solely to improve their products or to provide customized services or technologies to you. MS or Microsoft Corporation may disclose this information to others, but not in a form that personally identifies you.
- Internet-Based Services Components. The SOFTWARE may contain components that enable and facilitate the use of certain Internet-based services. You acknowledge and agree that MS, Microsoft Corporation or their affiliates may automatically check the version of the SOFTWARE and/or its components that you are utilizing and may provide upgrades or supplements to the SOFTWARE that may be automatically downloaded to your DEVICE. Microsoft Corporation or their affiliates do not use these features to collect any information that will be used to identify you or contact you. For more information about these features, please see the privacy statement at <http://go.microsoft.com/fwlink/?LinkId=25243>.
- Links to Third Party Sites. You may link to third party sites through the use of the SOFTWARE. The third party sites are not under the control of MS or Microsoft Corporation, and MS or Microsoft are not responsible for the contents of any third party sites, any links contained in third party sites, or any changes or updates to third party sites. MS or Microsoft Corporation is not responsible for webcasting or any other form of transmission received from any third party sites. MS or Microsoft Corporation are providing these links to third party sites to you only as a convenience, and the inclusion of any link does not imply an endorsement by MS or Microsoft Corporation of the third party site.
- Notice Regarding Security. To help protect against breaches of security and malicious software, periodically back up your data and system information, use security features such as firewalls, and install and use security updates.
- No Rental/Commercial Hosting. You may not rent, lease, lend or provide commercial hosting services with the SOFTWARE to others.
- Separation of Components. The SOFTWARE is licensed as a single product. Its component parts may not be separated for use on more than one computer.
- Additional Software/Services. This EULA applies to updates, supplements, add-on components, product support services, or Internet-based services components ("Supplemental Components"), of the SOFTWARE that you may obtain from DENSO CORPORATION, MS, Microsoft Corporation or their subsidiaries after the date you obtain your initial copy of the SOFTWARE, unless you accept updated terms or another agreement governs. If other terms are not provided along with such Supplemental Components and the Supplemental Components are provided to you by MS, Microsoft Corporation or their subsidiaries then you will be licensed by such entity under the same terms and conditions of this EULA, except that (i) MS, Microsoft Corporation or their subsidiaries providing the Supplemental Components will be the licensor with respect to such Supplemental Components in lieu of the DENSO CORPORATION for the purposes of the EULA, and (ii) TO THE MAXIMUM EXTENT PERMITTED BY APPLICABLE LAW, THE SUPPLEMENTAL COMPONENTS AND ANY (IF ANY) SUPPORT SERVICES RELATED TO THE SUPPLEMENTAL COMPONENTS ARE PROVIDED AS IS AND WITH ALL FAULTS. ALL OTHER DISCLAIMERS, LIMITATION OF DAMAGES, AND SPECIAL PROVISIONS PROVIDED BELOW AND/OR OTHERWISE WITH THE SOFTWARE SHALL APPLY TO SUCH SUPPLEMENTAL COMPONENTS. MS, Microsoft Corporation or their subsidiaries reserve the right to discontinue any Internet-based services provided to you or made available to you through the use of the SOFTWARE.
- Recovery Media. If SOFTWARE is provided by DENSO CORPORATION on separate media and labeled "Recovery Media"

you may use the Recovery Media solely to restore or reinstall the SOFTWARE originally installed on the DEVICE.



- **Backup Copy.** You may make one (1) backup copy of the SOFTWARE. You may use this backup copy solely for your archival purposes and to reinstall the SOFTWARE on the DEVICE. Except as expressly provided in this EULA or by local law, you may not otherwise make copies of the SOFTWARE, including the printed materials accompanying the SOFTWARE. You may not loan, rent, lend or otherwise transfer the backup copy to another user.
- **End User Proof of License.** If you acquired the SOFTWARE on a DEVICE, or on a compact disc or other media, a genuine Microsoft "Proof of License"/Certificate of Authenticity label with a genuine copy of the SOFTWARE identifies a licensed copy of the SOFTWARE. To be valid, the label must be affixed to the DEVICE, or appear on DENSO CORPORATION's software packaging. If you receive the label separately other than from DENSO CORPORATION, it is invalid. You should keep the label on the DEVICE or packaging to prove that you are licensed to use the SOFTWARE.
- **Product Support.** Product support for the SOFTWARE is not provided by MS, Microsoft Corporation, or their affiliates or subsidiaries. For product support, please refer to DENSO CORPORATION support number provided in the documentation for the DEVICE. Should you have any questions concerning this EULA, or if you desire to contact DENSO CORPORATION for any other reason, please refer to the address provided in the documentation for the DEVICE.
- **Termination.** Without prejudice to any other rights, DENSO CORPORATION may terminate this EULA if you fail to comply with the terms and conditions of this EULA. In such event, you must destroy all copies of the SOFTWARE and all of its component parts.
- **EXPORT RESTRICTIONS.** You acknowledge that SOFTWARE is subject to U.S. and European Union export jurisdiction. You agree to comply with all applicable international and national laws that apply to the SOFTWARE, including the U.S. Export Administration Regulations, as well as end-user, end-use and destination restrictions issued by U.S. and other governments. For additional information see <http://www.microsoft.com/exporting/>.





Preface

Thank you for purchasing this Intelligent Tester II.
Read this document carefully so that you can use this tester correctly and safely.







For safe usage

This document uses symbols for warnings, cautions, and prohibitions. These symbols and their meanings are as follows. Please make sure you fully understand the meanings of these symbols before reading the rest of this document.

 WARNING	This indicates an item for which incorrect handling can result in a major accident involving death or serious injury.
 CAUTION	Indicates an item for which incorrect handling can lead to injury or damage to property. Under certain conditions, more serious consequences may result.
 PROHIBITED	Indicates a prohibited method of handling.

 WARNING	
● Always observe the following rules. Failure to do so can result in heat generation, fire, blowout, or electrical shock.	
● Do not use or charge this device with anything other than the AC adapter specifically designed for this tester.	
● Do not disassemble or alter this tester.	
● Do not connect this tester to anything with a voltage exceeding the ratings of this tester.	

 **CAUTION**

- Do not leave this tester in any location subject to excessive heat for example in direct sunlight or inside a car on a sunny day. 
- Do not touch any metal parts when connecting the test leads to the measurement position, even when within the ratings range. 
- Do not work anywhere that water could come in contact with the equipment. 
- Do not drop this tester or subject it to a strong impact.
This could cause the liquid crystal leak from inside the tester.
A rash may result if the liquid crystal comes into contact with the skin.
If this happens, wash the skin with plenty of running water, then seek medical attention. 
- Block the wheels of the vehicle with chocks before carrying out work such as connecting the tester cable.
Failure to do so could result in an accident.
- Do not pass the cable for this tester over the engine compartment while the engine is running.
An accident may result in cable, test lead, or clothing becomes caught in a belt or pulley. 
- When working anywhere not be easily visible, for example under the vehicle, always remove the key from the ignition to ensure the vehicle cannot be moved.
Failure to do so could result in an accident.
- Do not work connect the tester cables etc. while the vehicle is running.
Doing so could result in an accident. 
- When working near the engine compartment, be careful of the engine and other high-temperature parts.
High-temperature parts can cause burns.

Trademarks

- Microsoft and Windows[®] CE are trademarks or registered trademarks of the Microsoft Corp. of the United States in the United States and other countries.
- CompactFlash[™] is a registered trademark of the SanDisk Corp. of the United States and is licensed to the CFA (CompactFlash[™] Association).

Table of contents

1 Before Use

Product Configuration	2
Standard Components	2
AC / DC Power Supply	4
Optional Accessories	5
Oscilloscope Accessories	5
Confirmation of the manufacturing model	6
Names of the Parts	8
Charging	11
Internal Battery	13
Connection	14
Connecting to the Vehicle	14
Connecting to a PC	15
Inserting a CF Card	16
Connecting the Oscilloscope Cartridge	17
Connecting the Probes	18

2 Basic Operations

Starting and Ending	21
Starting	21
Ending	23
Screen Configuration	24
Main Menu Buttons	24
Title Bar	25
Menu Bar	26
Basic Operations	29
Display Operation	29
Main Unit Operation	31
In Case of Error	32
Communication Errors	32
System Errors	33
Screen Lock Errors	33

3 Default Settings

Tool Option Function	35
Supplementary Functions (Set Up)	36
Clock Functions (Date/Time)	37
Language Selection Function (Language Select)	37
Unit Conversion Function (Unit Conversion)	38
Brand Selection Function (Brand Select)	38
Version Display Function (Version Information)	39
Touch Panel Compensation Function (Screen Configuration)	40
Data Storage Setting Function (Memory Select)	41
Button Setting Functions (Button Configuration)	41

4 Diagnostics Functions

System Selection	43
DTC Check	46
DTC Data Display	46
DTC Data Storage	47
DTC Data Clear	49
Freeze Frame Data Display	50
Data List	54
Data List Display	54
Display Switching.....	56
Snapshots.....	65
How to use the optional accessory Trigger Snapshot.....	67
Data List Manager.....	71
Active Test	73
Active Test Item Selection	73
Active Test Execution	74
Utilities	76
Explanation of Button Operations	77
Explanation of ECU Reprogramming Functions	78
Calibration File Manager.....	79

5 Saved Data Playback Functions

DTC Playback	82
Snapshot Playback	84
Playback With Snapshot Flag Set.....	86

6 Measurement Functions

Voltage Measurement Functions	89
Measurement Function Selection Menu	89
Voltage Display	90
Waveform Display.....	91
Calibration.....	93
Screen Image Save/Playback/Delete	94
Oscilloscope Functions	98
Oscilloscope Measurement Menu.....	98
Waveform Display.....	99
Trigger Menu.....	101
Screen Image Save/Playback/Delete	105

7 Handling

Handling Precautions	113
Disposal	113
Battery Replacement	114

8 Product Specifications

Intelligent Tester II Specifications	120
Voltage Measurement Function Specifications	121
Oscilloscope Function Specifications	121

9 After-Service

1 Before Use

1 Before Use

Product Configuration

Check that you have all the following standard components before using this tester.

For information on the Optional Accessories and Oscilloscope Accessories, reference Page 5.

Standard Components

Standard Set (Part Number: 95171-00791)

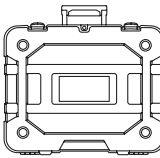
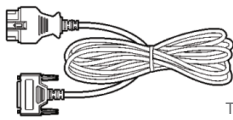
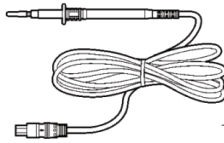
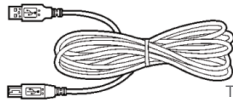
Part Name	Illustration	Part No.	Q'ty
Intelligent Tester II (without oscilloscope cartridge)	 T00009E	-	1
Storage Case	 T01075E	95171-20820	1
DLC3 Cable	 T00012E	95171-11110	1
Voltage Meter Probe	 T00013E	95171-10120	1
USB Cable	 T00014E	95171-10110	1
Screen Overlay		-	1
CD-ROM (Operator's Manual, Intelligent Viewer)		95009-13227	1
Quick Reference Manual		-	1
Repair Order Sheet		-	1
Warranty Terms Sheet		-	1

Oscilloscope Set (Part Number: 95171-00801)

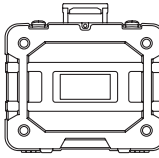
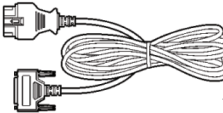
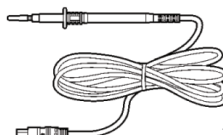
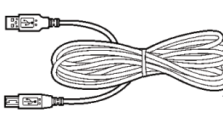
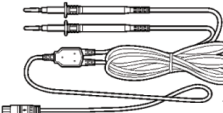
Part Name	Illustration	Part No.	Q'ty
Intelligent Tester II (with oscilloscope cartridge)	 T00009E	-	1
Storage Case	 T01075E	95171-20820	1
DLC3 Cable	 T00012E	95171-11110	1
Voltage Meter Probe	 T00013E	95171-10120	1
USB Cable	 T00014E	95171-10110	1
Oscilloscope Probe	 T00021E	95171-10500	2
Screen Overlay		-	1
CD-ROM (Operator's Manual, Intelligent Viewer)		95009-13227	1
Quick Reference Manual		-	1
Repair Order Sheet		-	1
Warranty Terms Sheet		-	1

AC / DC Power Supply

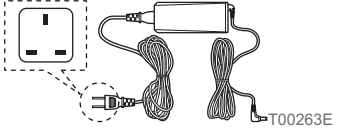
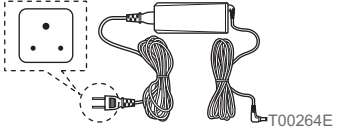
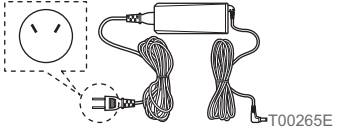
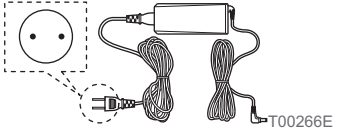
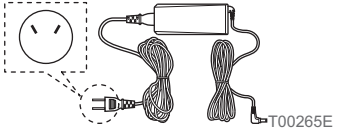
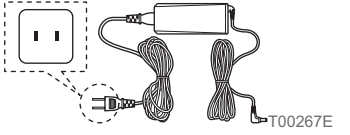
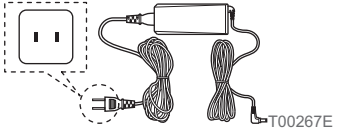
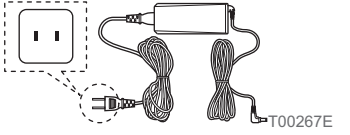
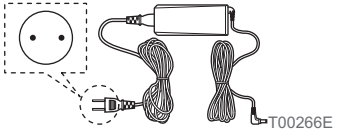
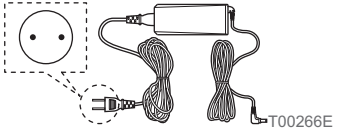
Part Name	Illustration	DENSO Part No.	Country	Q'ty
AC / DC Power Supply		95171-11650	Hong Kong Malaysia England Singapore	1
		95171-11660	South Africa	1
		95171-11670	Argentina	1
		95171-11680	Israel	1
		95171-11750	Australia New Zealand	1
		95171-10321	U.S.A Canada	1
		95171-11260	China	1
		95171-11440	Taiwan	1
		95171-11640	Korea	1
		95171-11690	Other countries	1

NOTE

- Some of power plugs are same shape, but they are different by regulations in each country. When you purchase AC/DC Power Supply, please refer the end user country in the above list and choose carefully the appropriate product number.

Optional Accessories

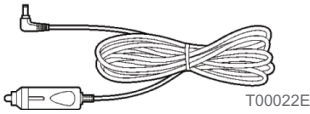
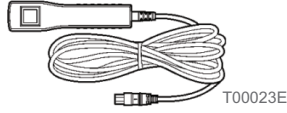
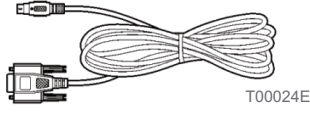
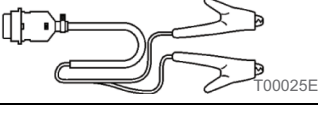
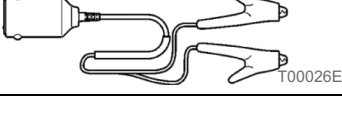
Part Name	Illustration	Part No.	Q'ty
DC Power Cable for Cigarette Lighter Socket	 T00022E	95171-10140	1
Trigger Snapshot	 T00023E	95171-10150	1
RS-232C Cable	 T00024E	95171-10130	1
Battery Power Cable (DLC3 Cable Type)	 T00025E	95171-10200	1
Battery Power Cable (Cigarette Lighter Type)	 T00026E	95171-10210	1
Screen Overlay		95171-10220	5
Replacement Battery		95171-10341	1
Storage Card (128MB)		95171-11121	1

Oscilloscope Accessories

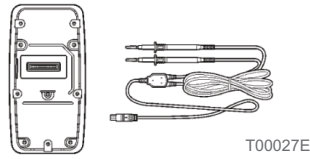
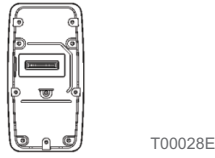
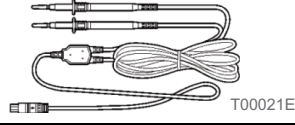
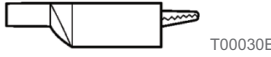
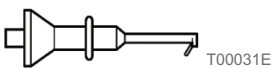
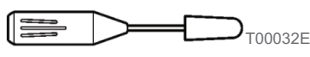
Part Name	Illustration	Part No.	Q'ty
Oscilloscope Set	 T00027E	95171-00070	Cartridge(1), Probe(2).
Oscilloscope Cartridge	 T00028E	95171-10240	1
Oscilloscope Probe	 T00021E	95171-10500	1
Attachment of Oscilloscope Probe (Clip Set)	 T00030E	95171-10170	Red(1), black(1).
Attachment of Oscilloscope Probe (IC Clip Set)	 T00031E	95171-10180	Red(1), black(1).
Attachment of Oscilloscope Probe (Needle Set)	 T00032E	95171-10190	Red(1), black(1).

Confirmation of the manufacturing model

There are two separate types of manufacturing models for the Intelligent Tester II.

Depending on the manufacturing model, there are certain features that differ.

In regards to the difference in features between manufacturing models, please refer to "Display Contrast".

Reference: Page 36 Display Contrast (Chapter 3. Default Settings/Tool Option Function/Supplementary Functions (Set Up))

The following will explain how to confirm the manufacturing model.

1. Turn the Intelligent Tester II power switch OFF.
2. Loosen the five screws on the rear of the main unit with a Philips screwdriver and take out the cartridge.

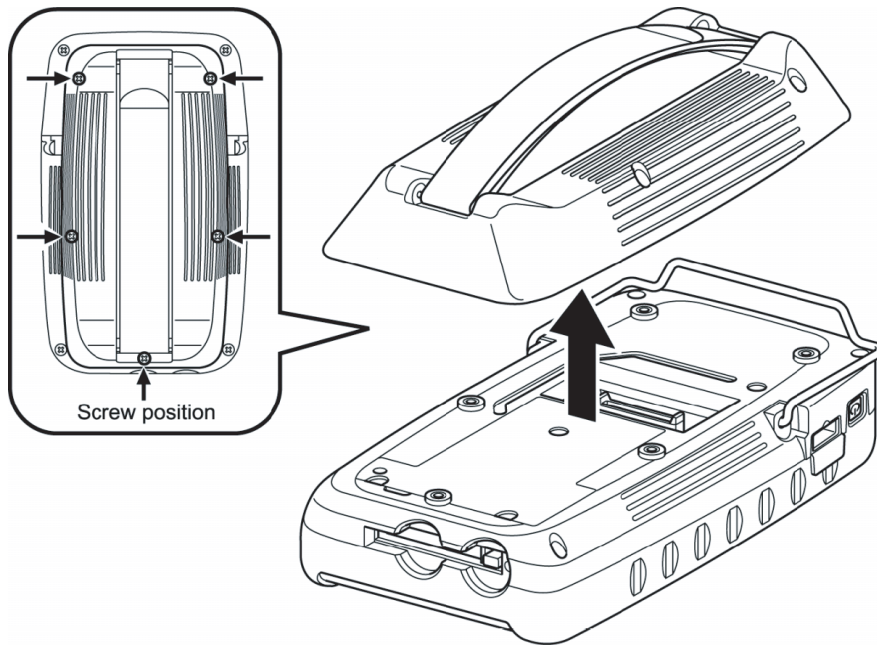

T00248E

3. Visually check the serial number label attached to the rear side of the Intelligent Tester II main unit and verify the manufacturing model.

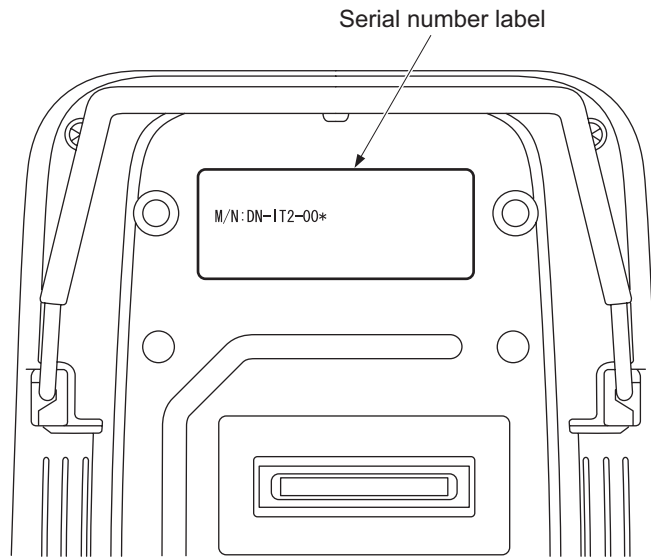

T01023E

DN-IT2-001: Intelligent Tester II manufactured on or before August 2008
DN-IT2-002: Intelligent Tester II manufactured on and after September 2008

4. Mount the cartridge in the main unit and tighten the five screws to a torque of 0.5 ± 0.1 Nm with a Philips screwdriver.

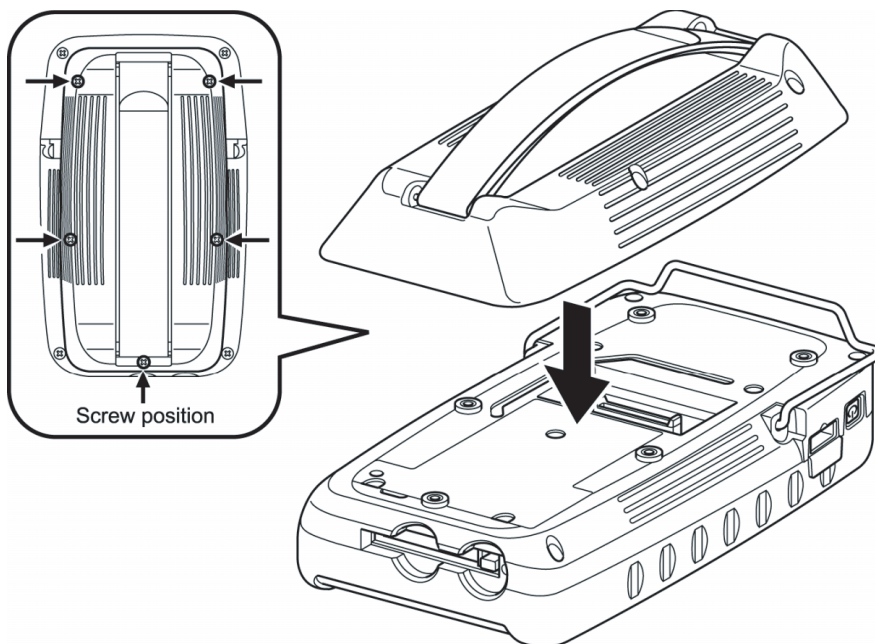

T00255E

⚠ CAUTION

- When connecting the cartridge with the built-in to oscilloscope to the main unit, carefully check the configuration of the connector and gently insert the cartridge straight in. Inserting the cartridge at a slant can break the connector pins.
- Be careful not to touch the connector section of the main unit or the cartridge with your hands.

Names of the Parts

The names of the Intelligent Tester II parts are as follows.

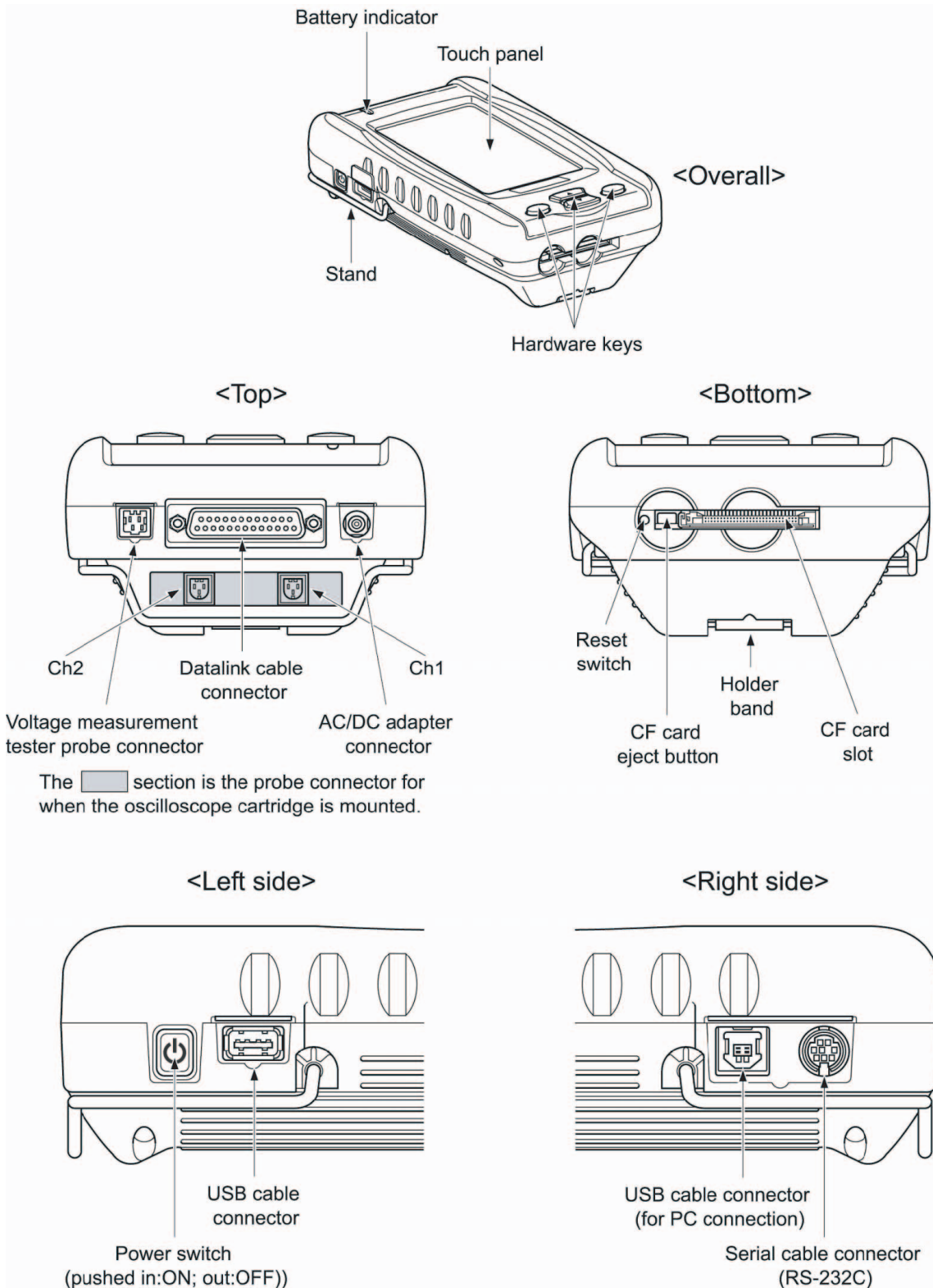

T00033E

How to Use the Holder Band

Slip your hand between the holder band and the Intelligent Tester II.

The length of the holder band can be adjusted using the velcro strap. If the holder band is too loose, adjust it so that the Intelligent Tester II is held securely to your hand.

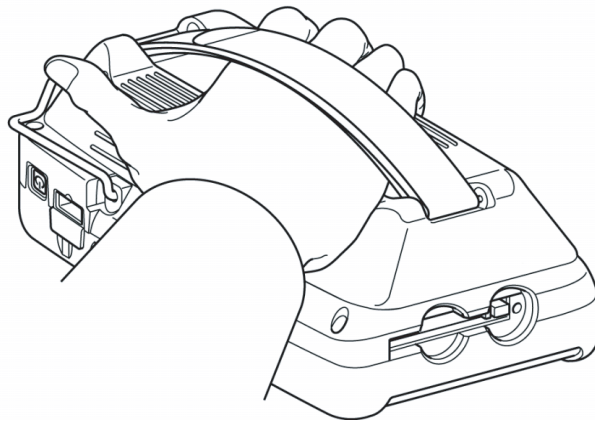
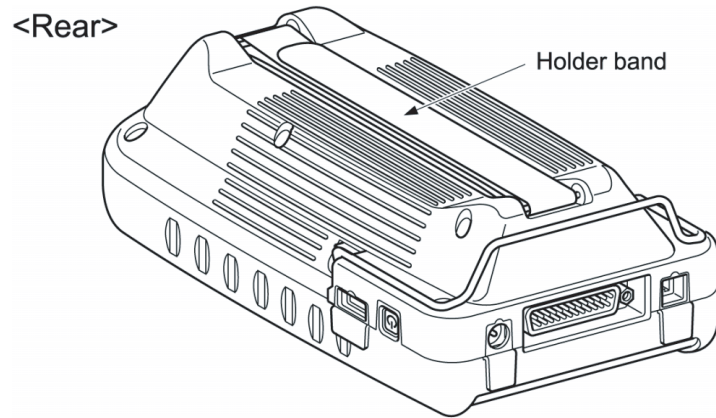

T00034E

How to Use the Stand

The stand can be pulled out and used as shown below.

To return the stand to its original position, open the stand coupling section horizontally, and then push it back into place.

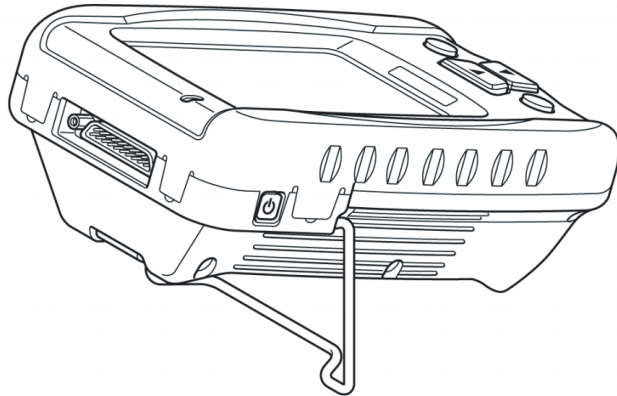

Raised stand position

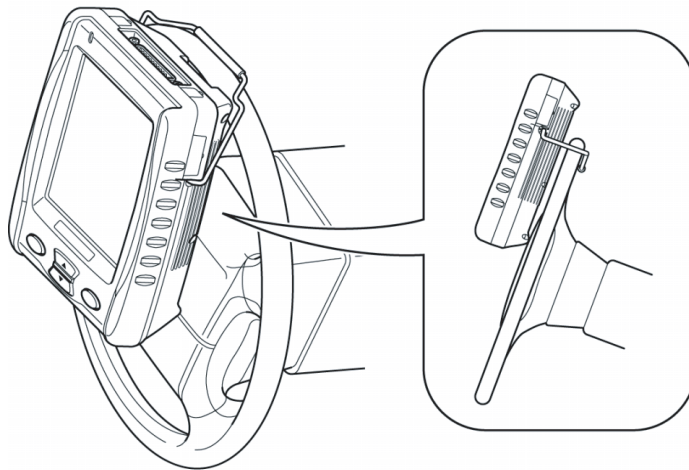

Attached to steering wheel

T00035E

NOTE

- Be careful when using the stand on an easily damaged surface, for example a wooden steering wheel.

Charging

The main unit of the Intelligent Tester II has a special internal rechargeable battery (lithium ion battery). This battery is not charged when the Intelligent Tester II is shipped from the factory, so be sure to charge the battery before using the tester.

NOTE

- There is no need to turn OFF the power switch on the Intelligent Tester II while charging. The Intelligent Tester II can be charged with the power ON or OFF.
- It takes approximately five hours to fully charge the battery from a completely discharged state, regardless of whether the power switch is ON or OFF.

1. Connect the AC/DC adapter DC plug to the AC/DC adapter connector of the Intelligent Tester II.

2. Plug the AC/DC adapter power plug into an electrical socket.

Charging starts and the battery indicator on the Intelligent Tester II lights up red. Charging is complete when the battery indicator changes from red to green.

3. Disconnect the AC/DC adapter DC plug from the AC/DC adapter connector of the Intelligent Tester II.

4. Unplug the AC/DC adapter power plug from the electrical socket.

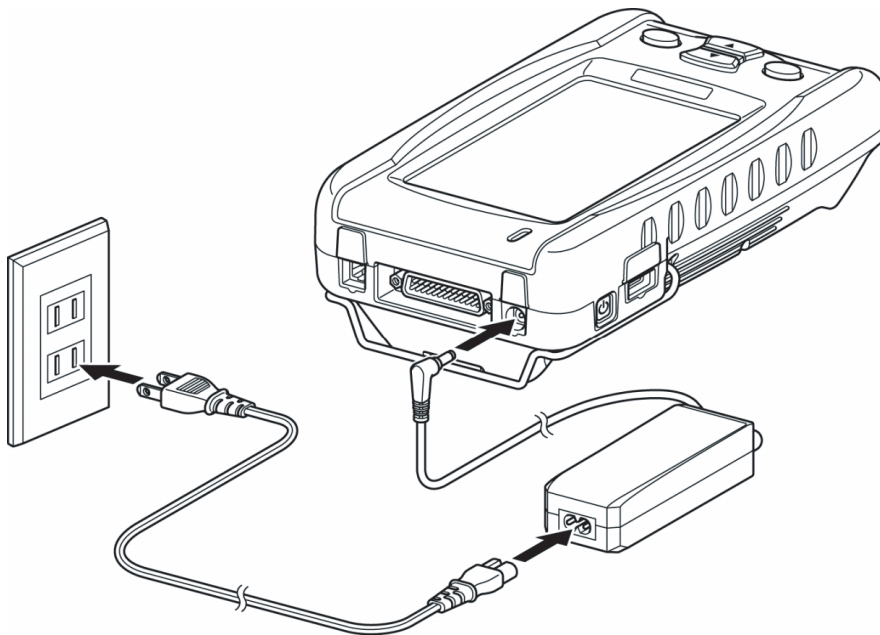

T00036E

CAUTION

- Do not use devices other than the optional AC/DC adapter when charging the battery of the Intelligent Tester II.

Using other adapters may prevent battery charging, and cause heating of and damage to the charger.

- Do not leave the AC/DC adapter plugged into the electrical socket after charging is complete.

Dust can build up between the socket and the plug and cause tracking and fire.

- If the battery is charged while outside the usage temperature range, the battery indicator flashes.

Continued charging in this condition could damage the equipment, so discontinue charging.

- Do not connect the AC/DC adapter to the Intelligent Tester II, when using the oscilloscope function.

NOTE

- The Intelligent Tester II can be connected to the vehicle with the datalink cable to run off the vehicle battery when the tester internal battery is not charged.

In this state, the Intelligent Tester II internal battery will charge using the vehicle power, so take care not to run down the vehicle battery.

- When using the Intelligent Tester II without connecting it to the vehicle (for example when using it as an oscilloscope), monitor the amount of power remaining in the battery and charge it with the AC/DC adapter when it runs low.

The onboard/offboard check screen can be used to check the amount of power remaining in the battery.

Reference: [Page 25 Battery icon \(Chapter 2. Basic Operations/Screen Configuration/Title Bar\)](#)

- It is normal for the main unit of the Intelligent Tester II to heat up during charging.

- The Intelligent Tester II may be left connected to the AC/DC adapter when the charging is complete.

Internal Battery

When the Intelligent Tester II is not connected to the vehicle, such as with the datalink cable or the external power cable, the Intelligent Tester II is powered by its internal battery.

When the Intelligent Tester II is run on its internal battery, a fully charged battery will last approximately 80 minutes if there is an oscilloscope cartridge or approximately one hour if there is not.

You can check the amount of power remaining in the battery with the onboard/offboard check screen.

Reference: Page 25 Battery icon (Chapter 2. Basic Operations/Screen Configuration/Title Bar)

The internal battery is a consumable part. When the time that a fully charged battery can be used becomes extremely short, replace the internal battery.

Replace the internal battery with a new internal battery.

The Intelligent Tester II uses a specially made internal battery. When it becomes necessary to replace the internal battery, please purchase a replacement battery and install it according to the replacement instructions.

Reference: Page 114 Battery Replacement (Chapter 7. Handling)

Connection

This section explains how to connect the tester to a vehicle or PC, how to mount a CF card, and how to connect the probes.

Connecting to the Vehicle

Use the datalink cable to connect the Intelligent Tester II to the vehicle.

Check the position of the vehicle-side datalink connector (DLC 3) in the vehicle repair manual.

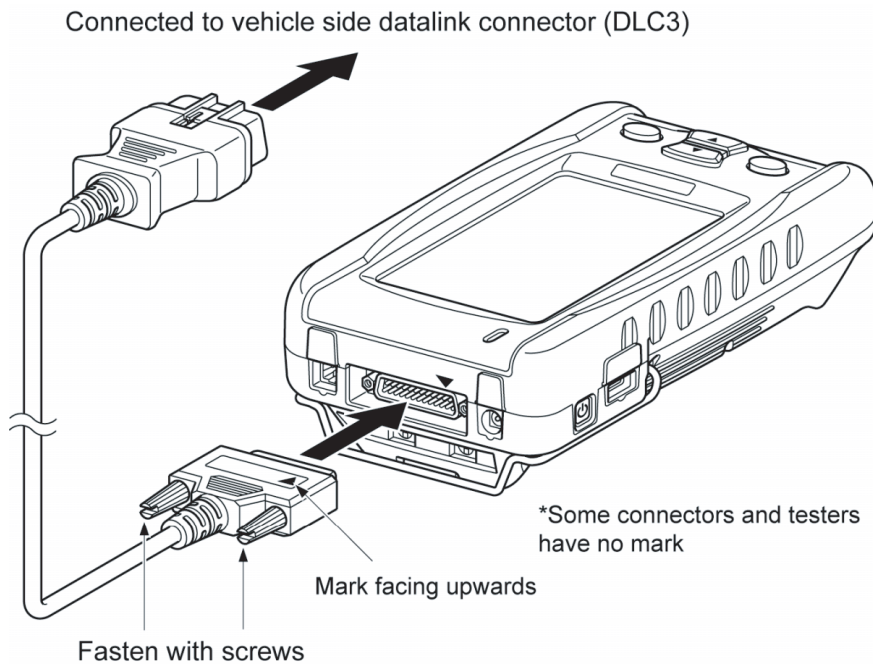

T00037E

⚠ CAUTION

- When connecting the datalink cable to the Intelligent Tester II and the vehicle side datalink connector (DLC 3), gently insert it straight into the connector.

Inserting the cable at a slant can break the connector pins.

- When connecting the data link cable to the Intelligent Tester II, make sure the connector is in the right direction.

(If the data link cable connector has a ▲ mark, it should be facing upwards.)

If you connect it the wrong way up or insert it at an angle, there is a risk of damaging the connector terminal and causing a malfunction of the vehicle or Intelligent Tester II.

NOTE

- The carrying case can remain on even when the data link cable is connected to the Intelligent Tester II. It is recommended that you keep them connected all the time.

Connecting to a PC

Use a USB cable or serial cable (RS-232C) to connect the Intelligent Tester II to a PC. It is necessary to connect to a PC in the following cases:

- When upgrading the Intelligent Tester II software;
- When rewriting the vehicle computer (ECU) program;
- When downloading data stored in the Intelligent Tester II into your PC.

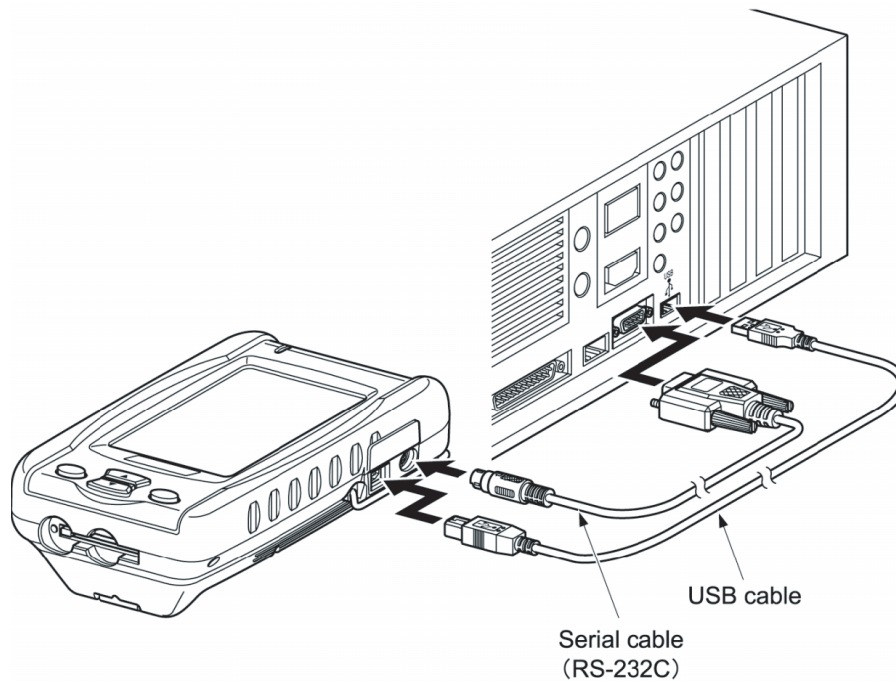

T00038E

CAUTION

- When connecting a USB cable or serial cable (RS-232C) to the Intelligent Tester II and the PC, gently insert the cable straight into the connector.
Inserting the cable at a slant can break the connector pins.

NOTE

- When downloading data to a PC, use the accessory Intelligent Viewer software.
For details on usage methods, see the Intelligent Viewer user's manual.

Inserting a CF Card

The Intelligent Tester II can use CF (CompactFlash™) cards.

CAUTION

- Please use the recommended CF card (DENSO Supply No. 95171-11121). We cannot guarantee proper operation if a different CF card is used.

The methods for inserting/removing CF cards are as follows.

● Inserting a CF card

Gently insert the CF card with the larger indentation (notch) facing to the left side.

When the CF card is fully inserted and set correctly, the CF card eject button is click out.

● Removing a CF card

Press the CF card eject button.

The CF card will eject slightly, so gently pull it out the rest of the way.

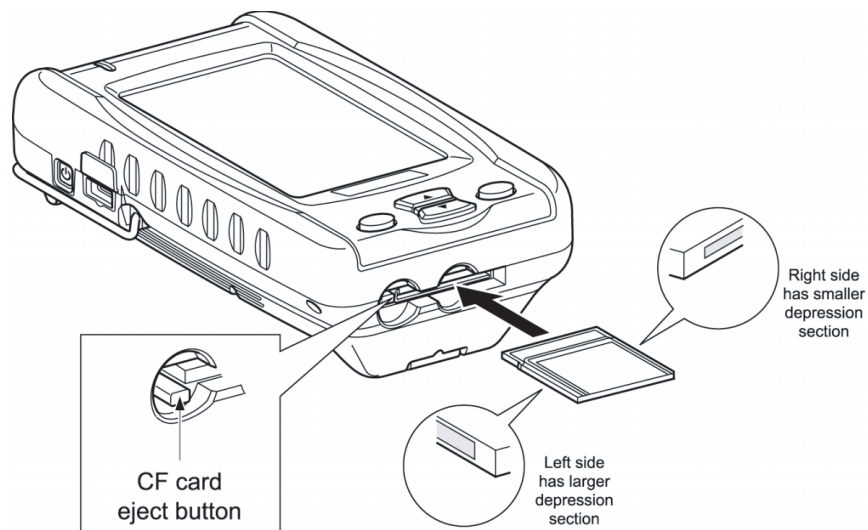

T00039E

CAUTION

- Do not insert anything but a CF card in this card slot.
- Do not pull out a CF card when power is on.

Connecting the Oscilloscope Cartridge

If you purchased the optional cartridge with the built-in oscilloscope, it is necessary to replace the standard cartridge with this cartridge.

Loosen the five screws securing the standard cartridge and remove the cartridge.

Replace the standard cartridge with the built-in oscilloscope cartridge, and secure it in place by tightening the five screws to a torque of 0.5 ± 0.1 Nm.

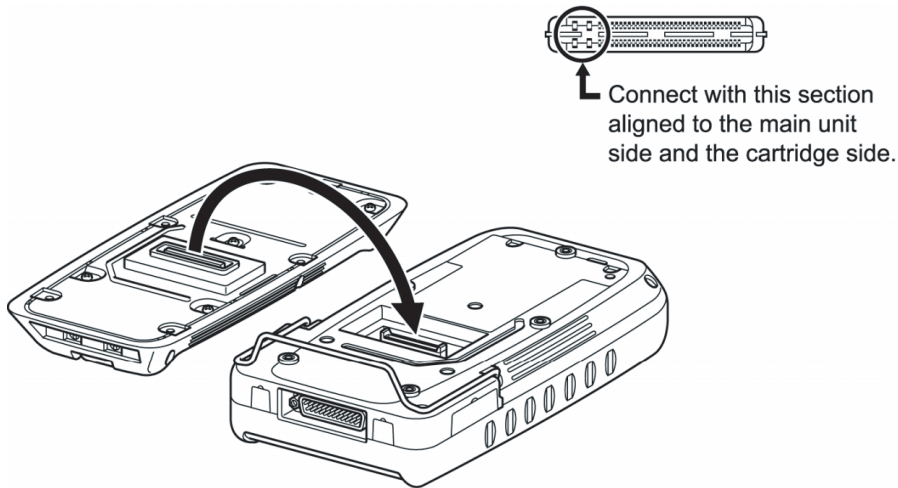

T00040E

CAUTION

- Always make sure the power to the Intelligent Tester II is OFF before replacing the cartridge.
- When connecting the cartridge with the built-in to oscilloscope to the main unit, carefully check the configuration of the connector and gently insert the cartridge straight in.
Inserting the cartridge at a slant can break the connector pins.
- Be careful not to touch the connector section of the main unit or the cartridge with your hands.

Connecting the Probes

There are two types of probe, the voltage measurement tester probe and the oscilloscope probe. The oscilloscope probes are an accessory for the oscilloscope.

Connecting the oscilloscope probes

The probe tip is secured to the oscilloscope probe with a screw, regardless of whether the probe is an IC clip type, Needle type, or alligator clip type.

The following three probe heads can be used according to the application.

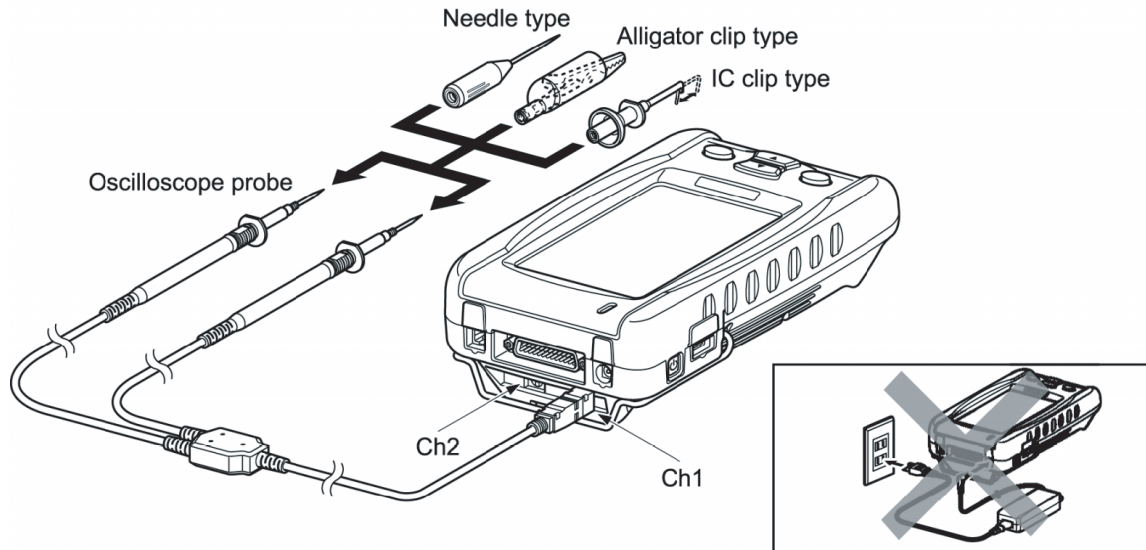

Connect the oscilloscope probes to Ch1 or Ch2.
The probes can be connected to both Ch1 and Ch2.

T00041E

CAUTION

- When connecting the probe to the Intelligent Tester II, gently insert it straight into the connector. Inserting the probe at a slant can break the connector pins.
- The tip of the probe is sharp, so handle it carefully.
- Do not connect the AC/DC adapter to the Intelligent Tester II, when using the oscilloscope function.

Connecting the voltage measurement tester probe

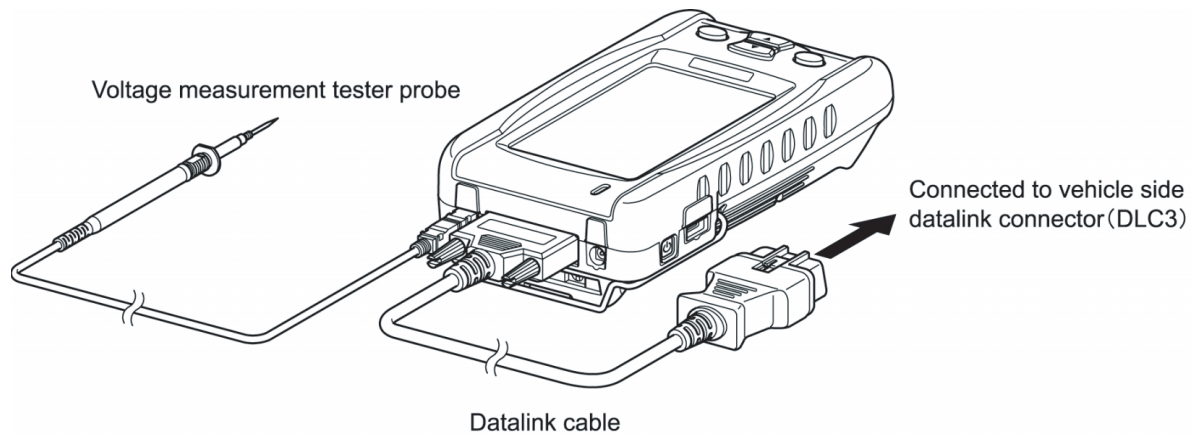

In order to measure correctly,
always connect the datalink cable.

T00042E

⚠ CAUTION

- When connecting the probe to the Intelligent Tester II, gently insert it straight into the connector. Inserting the probe at a slant can break the connector pins.
- The tip of the probe is sharp, so handle it carefully.

NOTE

- In addition to the datalink cable, the optional cigarette lighter cable or battery cable can also be used to ensure correct measurement.

2 Basic Operations

2 Basic Operations

Starting and Ending

Starting

1. Connect the Intelligent Tester II and vehicle side datalink connectors (DLC3) with the datalink cable.
Reference: Page 14 Connecting to the Vehicle (Chapter 1. Before Use/Connection)
2. Turn the vehicle ignition switch ON.

NOTE

- Communication with the vehicle computer (ECU) is not possible if the ignition switch is at OFF or ACC. When the Intelligent Tester II is turned ON, always switch the ignition switch ON or start the engine.
- When the Intelligent Tester II is used as measurement function (voltage measurement, oscilloscope), it will work even if the ignition switch is at OFF or ACC.
- If the Intelligent Tester II is connected to the vehicle's diagnostic connector (DLC3) by a datalink cable and supplied with power via an AC/DC adapter or DC power cable for a cigarette lighter socket, the Intelligent Tester II can be operated even with its power switch turned off.

3. Press the Intelligent Tester II power switch to turn the power ON.

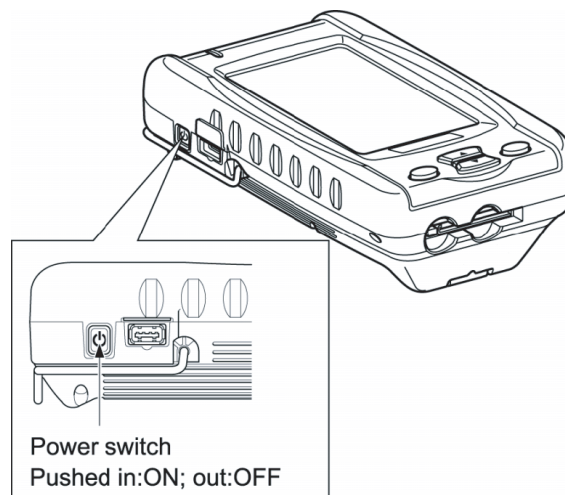

T00043E

⚠ CAUTION

- During startup, never switch the Intelligent Tester II power switch OFF until the onboard/offboard check screen is displayed.

After the opening screen is displayed, the display automatically switches to the onboard/offboard check screen.

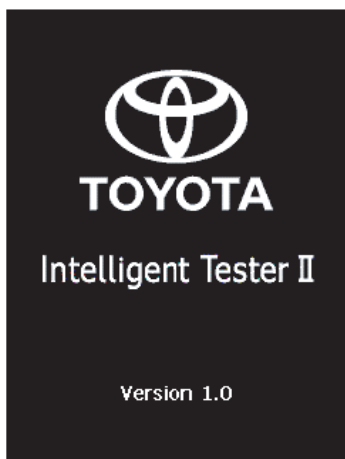

Toyota opening screen T00044E



Lexus opening screen T00045E

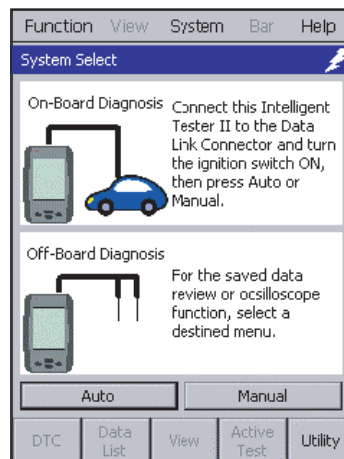

Onboard/offboard check screen T00046E

NOTE

- There are two opening screens, one for Toyota and one for Lexus. These are selected using the brand select function. The factory setting is the Toyota opening screen.

Reference: Page 38 Brand Selection Function (Brand Select) (Chapter 3. Default Settings/Tool Option Function)

4. When using the Intelligent Tester II as the OBD function, touch **Auto** or **Manual** on the onboard/offboard screen.

The system select screen is displayed.



Onboard/offboard check screen T00047E

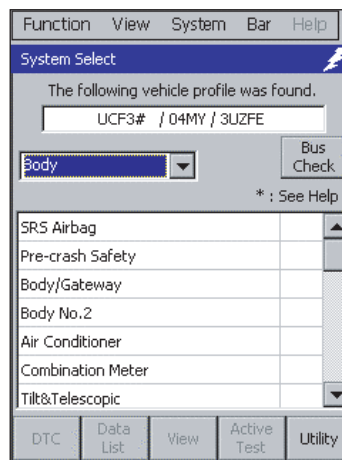

System select screen T00048E

NOTE

- To execute the OBD function, choose whether the vehicle is to be selected automatically or manually.

Reference: Page 43 Automatic Vehicle Selection (Chapter 4. Diagnostics Functions/System Selection)

Reference: Page 44 Manual Vehicle Selection (Chapter 4. Diagnostics Functions/System Selection)

- When using Voltage meter or another measurement function, select that function from the [Utility] menu.

Ending

CAUTION

- If the power to the Intelligent Tester II is switched OFF during an active test, the actuator may remain in the drive state. Always end the active test before switching the power OFF.

1. Turn the vehicle ignition switch OFF.
2. Press the Intelligent Tester II power switch to turn the power OFF.

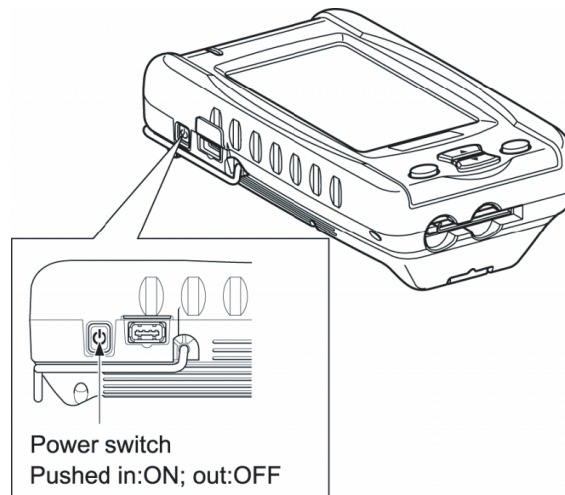

T00049E

3. Disconnect the datalink cable from the vehicle side datalink connector (DLC3).

CAUTION

- When disconnecting the datalink cable from vehicle side datalink connector (DLC 3), gently pull it straight out of the connector.
Pulling the cable at a slant can break the connector pins.
- When pulling the cable out, hold it by the connector section, and never by the cord section.
Pulling on the cord section can break the lines in the cable.

Screen Configuration

The screen configuration for the Intelligent Tester II is as follows.

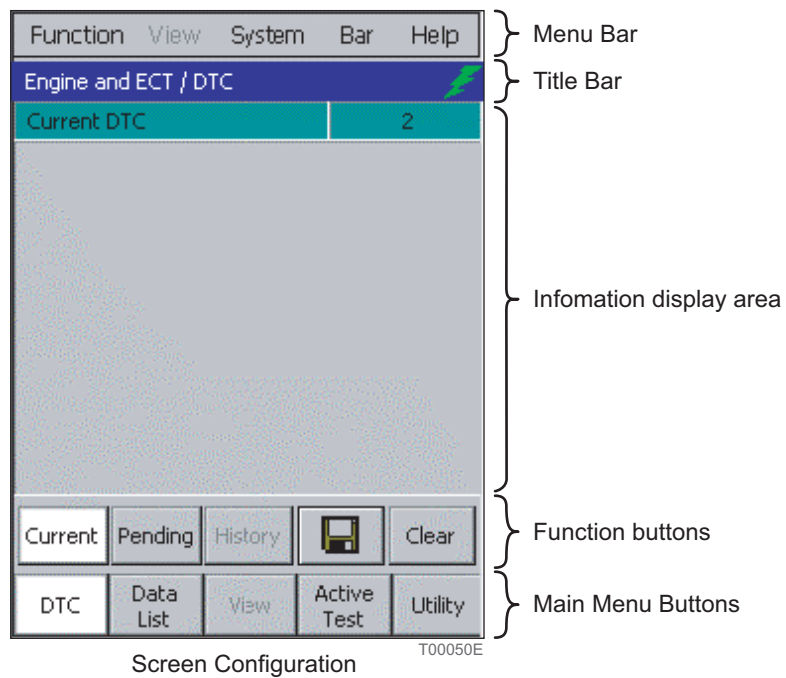

NOTE

- The Intelligent Tester II display is a touch panel, so use your fingers to operate it.
- When a menu bar or button item is displayed in gray, this indicates that the item is disabled.

Main Menu Buttons

The main menu buttons are composed of frequently used functions. These functions can be selected from the menu bars, but the main menu buttons enable these functions to be started at one touch.

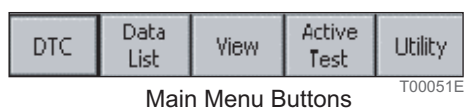

◆ ACTIVE KEY

- | | |
|-------------|---|
| DTC | Starts the DTC check. Freeze frame data can also be checked with a DTC check. |
| Data List | Starts the data list. Snapshots can also be recorded with the data list. |
| View | Switches the data list display format. |
| Active Test | Starts an active test. |
| Utility | Starts the utility. |

Title Bar

The title bar displays the ECU name and function names. Icons displaying the power status and communications status are also shown at the right end.

The icon display at the right end of the title bar varies according to the connection between the Intelligent Tester II and the vehicle computer (ECU).

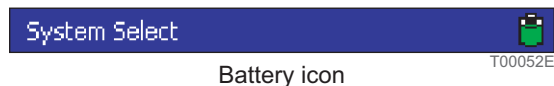

Battery icon



Connector icon

Battery icon

This icon is displayed when the Intelligent Tester II and the vehicle computer (ECU) are not connected, to show that the Intelligent Tester II is running on its internal battery. The battery icon also functions as an indicator showing the charge level (remaining power) for the internal battery.

Connector icon

This icon is displayed when the Intelligent Tester II and the vehicle computer (ECU) are correctly connected, to show that the Intelligent Tester II is running on vehicle power. The connector icon also functions as an indicator by showing the communications status with its color.

When communication starts, the connector icon changes color according to the communication speed: low speed (green), medium speed (yellow) and high speed (red). The communication speed is determined by the vehicle computer (ECU).

Menu Bar

Five menu titles are displayed in the menu bar.
Touching a menu titles displays the list of its functions.

[Function] menu

The [Function] menu is used to select the program for execution. The functions that can be selected from the [Function] menu are as follows.

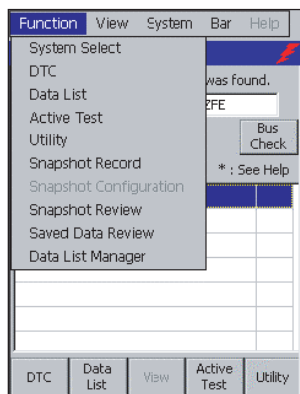

[Function] menu T00054E

Function	Contents	Reference page
System Select	Moves to the system select screen.	P.43
DTC	Starts the DTC check. Freeze frame data can also be checked with a DTC check.	P.46
Data List	Starts the data list. Snapshots can also be recorded with the data list.	P.54
Active Test	Starts an active test.	P.73
Utility	Starts the utility.	P.76
Snapshot Record	Starts snapshot recording.	P.65
Snapshot Configuration	Starts snapshot detail setting.	P.68
Snapshot Review	Displays a saved snapshot data file.	P.84
Saved Data Review	Displays a saved DTC data file.	P.82
Data List Manager	Starts the data list manager.	P.71

[View] menu

The data list display form can be selected from the [View] menu. However, the [View] menu is only enabled when the [Data List] or [Active Test] function is selected from the [Function] menu. Functions that can be selected from the [View] menu are as follows.

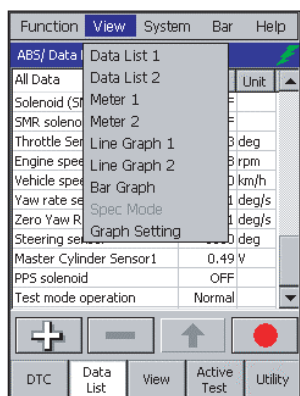

[View] menu

T00055E

Function	Contents	Reference page
Data List 1	Displays the monitor items, values, and units in a list on one line.	P.58
Data List 2	Displays the monitor items (abbreviations), values, and units in a list on two lines.	P.59
Meter 1	Displays the monitor items, values (enlarged), maximum, and minimum values, and units in a list on one line.	P.60
Meter 2	Displays the monitor items (abbreviations), values (enlarged), and units in a list on two lines.	P.61
Line Graph 1	Displays the monitor items, values (broken-line graph), maximum, and minimum values, and units in a list on one line.	P.62
Line Graph 2	Displays the monitor items, values, and units in a list on one line together with a broken-line graph of the values.	P.63
Bar Graph	Displays the monitor items, values (bar graph), maximum, and minimum values, and units in a list on one line.	P.64
Graph Setting	<ul style="list-style-type: none"> • Sets the vertical axis for graphing the displayed data. (Line Graph1, Line Graph2, Bar Graph only) • Sets the buzzer to ON/OFF for when the maximum value or minimum value displayed on a graph other than for Data List1 or Data List2 is updated. 	-

[System] menu

Tool option functions (default setting functions) can be selected from the [System] menu. The functions that can be selected from the [System] menu are as follows.

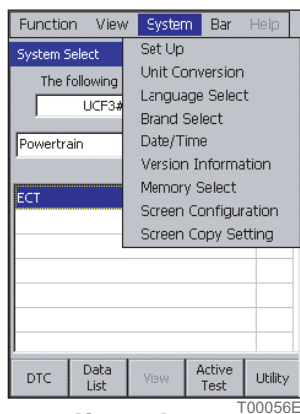

[System] menu

Functions	Contents	Reference page
Set Up	Sets the backlight and display brightness, and the buzzer.	P.36
Unit Conversion	Sets the speed, temperature, pressure, and flow units.	P.38
Language Select	Selects the language used with the Intelligent Tester II.	P.37
Brand Select	Sets the brand for the opening screen (Toyota or Lexus).	P.38
Date/Time	Sets the date and time.	P.37
Version Information	Displays version information for the Intelligent Tester II.	P.39
Memory Select	Sets the data storage destination (memory or card).	P.41
Screen Configuration	Corrects the touch panel touch keys.	P.40
Button Configuration	Sets the shortcut keys, and switches the screen image save function ON/OFF.	P.41

Bar

- The function button displays are switched ON/OFF by touching the [Bar].

Help

- When [Help] is touched with [Data List] or [Active Test] selected, an explanation of the item is displayed.
- When [Help] is touched with [Utility] selected, an explanation of the functions is displayed.

Basic Operations

Display Operation

Touch panel operation

The display for the Intelligent Tester II is a touch panel. Operations on the display are all operated using your fingers.

- To select an item from a list or press a button, briefly tap the item or button with your finger.

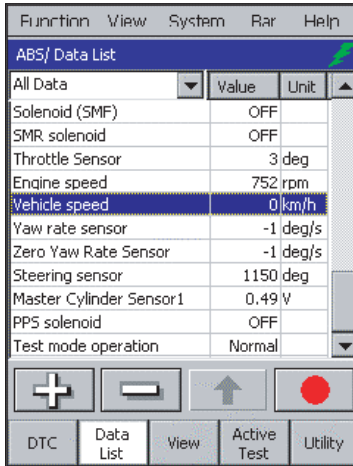

Example of screen displaying items in a list

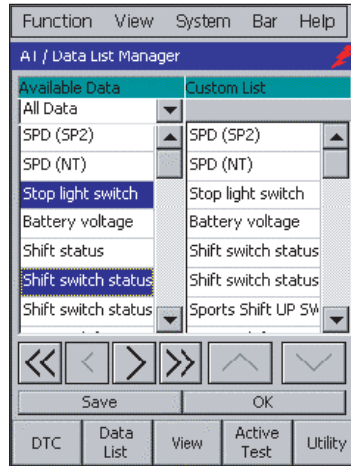

Example of a screen displaying buttons

CAUTION

- To protect the display from scratches, always insert the screen overlay.
- Always operate the touch panel with your fingers. Never use any other object.

Replacing the screen overlay for the display

- When removing the screen overlay, grasp the screen overlay with your fingers and remove.
- Use a soft cloth to wipe the surface of the touch panel clean of any dust etc.
- When inserting the screen overlay, insert it into the gap between the top section and the bottom section of the display.

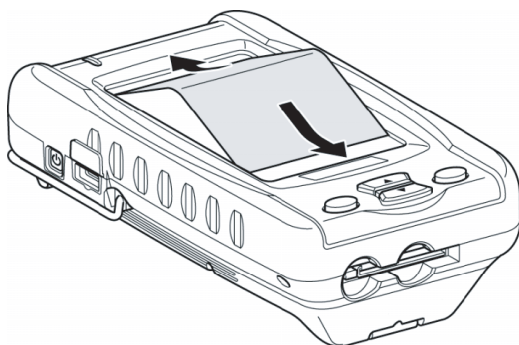

Insertion

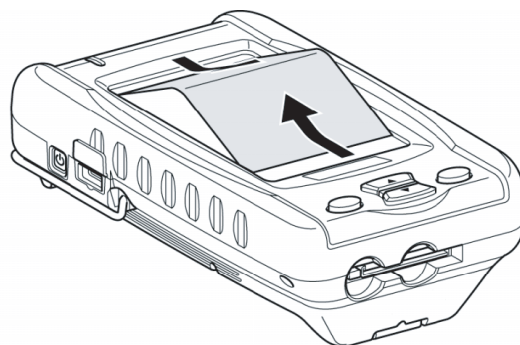





Removal

T00059E

Scroll bar operation

A scroll bar is displayed on a screen displaying a list. The scroll bar can be used to scroll up and down the list.

- If you move your finger up/down while touching the scroll bar, the list scrolls up/down.
- Touching  /  once scrolls the list up/down one line.
- Touching and holding  /  scrolls the list up/down continuously.

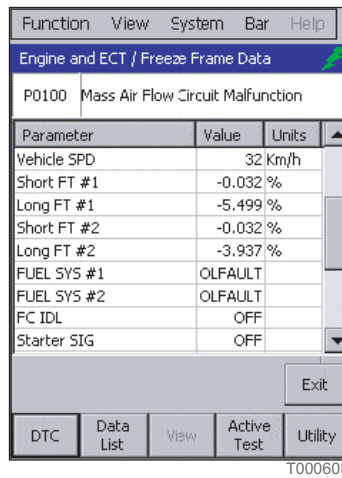



Example of screen with scroll bar displayed

Software keyboard operation

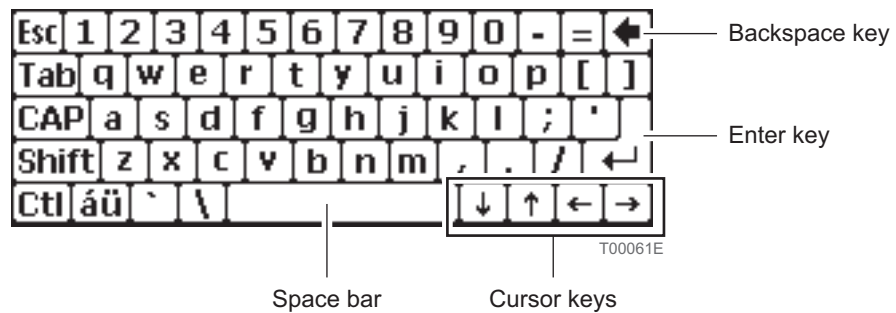
When it is necessary to input characters on the screen, use the software keyboard.



Methods for use are as follows.

- The keyboard can input English alphanumerics.
- To delete a character, use the  (backspace) key.
- To switch between uppercase and lowercase English letters, use the  key.
- To input accented characters (such as á and Ä) not displayed on the keyboard, touch the  key. The keyboard display switches to accented characters.

Main Unit Operation

The main unit of the Intelligent Tester II has four hardware keys.

All operations of the Intelligent Tester II can be carried out on the display, but four hardware keys are used for frequently-used functions in order to improve operability.

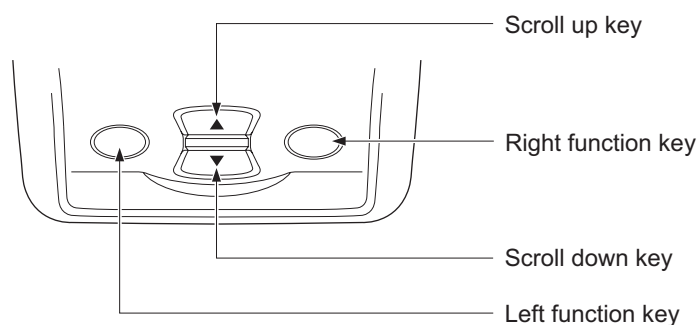

T00062E

The hardware key functions are as follows.

Hardware key	Functions
Scroll up key	This key is enabled when a list (and a scroll bar) is shown on the display. It scrolls the list up. Pressing this key once scrolls the list up one line; holding the key down scrolls the list up continuously.
Scroll down key	This key is enabled when a list (and a scroll bar) is shown on the display. It scrolls the list down. Pressing this key once scrolls the list down one line; holding this key down scrolls the list down continuously.
Left function key	Used to return from the screen currently being displayed to the onboard/offboard check screen.
Right function key	<ul style="list-style-type: none"> • Normally used to return to the system select screen. • Used to start/stop measurement during voltage measurement and measurement with the oscilloscope function. • When screen image saving is set to "ON", pressing this key saves the screen image. <i>Reference: Page 41 Button Setting Functions (Button Configuration) (Chapter 3. Default Settings/Tool Option Function)</i>

In Case of Error

Communication Errors

If a communication error occurs while the Intelligent Tester II is in use, the following error message is displayed.

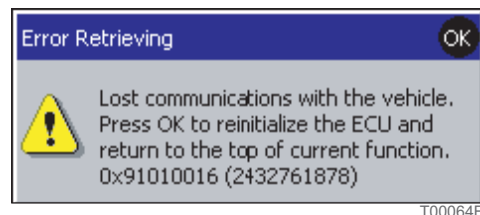
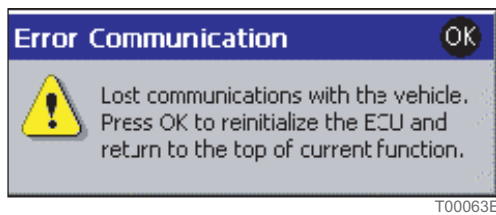

If a communications error occurs, check the error according to the following procedure.

1. Touch [OK] at the top right of the error message window.

This closes the window and returns to the head screen of the function in which the communication error occurred.

2. Turn the vehicle ignition switch OFF.
3. Turn the Intelligent Tester II power switch OFF.

A connection defect for the datalink cable may be the cause of a communication error. Check the datalink connector (DLC 3) connection at the Intelligent Tester II and vehicle sides.

4. Restart the Intelligent Tester II.

Check if the communication error occurs again.

If so, connect the Intelligent Tester II to another vehicle (of the same model) and check if a communication error occurs with that vehicle.

- If no communication error occurs

There may be a problem with the vehicle. Inspect and repair the vehicle as necessary, in accordance with the vehicle repair manual.

- If a communication error occurs

There may be a problem with the Intelligent Tester II.

System Errors

If a system error occurs while the Intelligent Tester II is in use, an error message dialog box like the following is displayed.

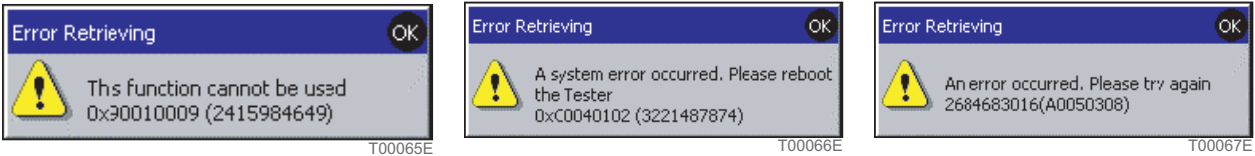

If a system error occurs, follow the procedure listed below.

1. Touch in the error message dialog box.
2. Turn the Intelligent Tester II power switch OFF.
3. Turn the Intelligent Tester II power switch ON to restart the Intelligent Tester II.

If restarting the Intelligent Tester II does not eliminate the system error, write down the error message and ask the service reception staff.

Screen Lock Errors

If there is no response when the touch keys are pressed or the screen locks up when using the Intelligent Tester II, follow the procedure listed below.

1. Turn the Intelligent Tester II power switch OFF.
2. Press the reset switch beside the CF card slot.

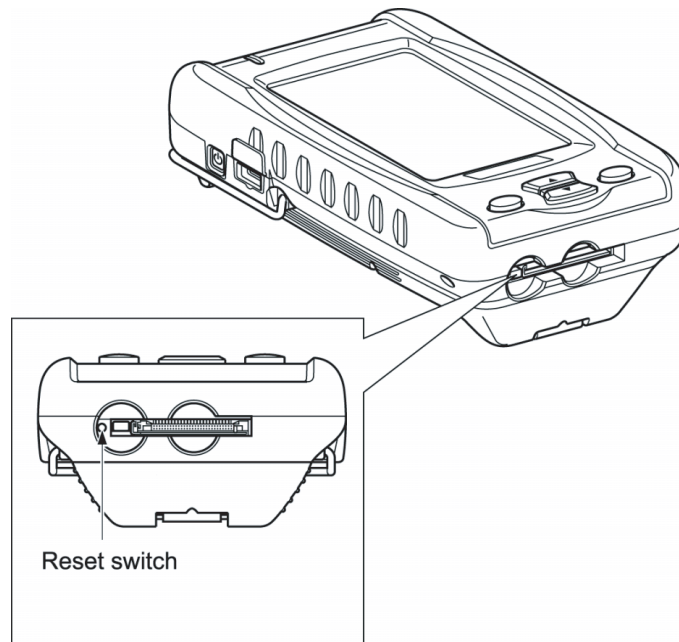

3. Turn the Intelligent Tester II power switch ON to restart the Intelligent Tester II.

T00068E

3 Default Settings

3 Default Settings

Tool Option Function

The default setting tool option function changes the default settings (the factory settings) for the Intelligent Tester II.

The various tool option functions can be selected from the [System] menu on the main menu screen title bar.

This section explains the default setting functions.

NOTE

- Updating the diagnosis software will cause all setting parameters changed using the tool option function to be reset to their default settings (factory settings).
After updating diagnosis software, go back and manually change setting parameters to their condition before software update, as needed.

Depending on the manufacturing model of the Intelligent Tester II, there are certain features that differ.

In regards to how to confirm the manufacturing model, please refer to "Confirmation of the manufacturing model".

Reference: Page 6 Confirmation of the manufacturing model (Chapter 1. Before Use)

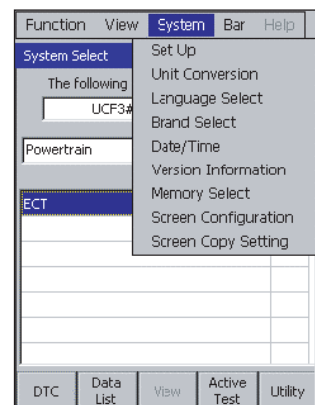

[System] menu

T00069E

Supplementary Functions (Set Up)

The supplementary functions set the level of back light brightness and the display contrast, and turn the buzzer ON/OFF.

Back Light

Adjusts the back light brightness. Sliding the indicator to the left increases the level of brightness.

NOTE

- Making the back light brighter uses more power. When the Intelligent Tester II is running on its internal battery, we recommend that the back light be dimmed for as possible.

Display Contrast

Adjusts the display contrast. Sliding the indicator to the left darkens the display.

NOTE

- For manufacturing model "DN-IT2-002", adjusting the display contrast settings will not affect actual display contrast. Please note that this is not a malfunction.

Buzzer

Select ON/OFF for the buzzer (touch sound).

◆ACTIVE KEY

- | | |
|---------------------------------------|-----------------------------------|
| <input type="button" value="OK"/> | Activates the selected settings. |
| <input type="button" value="Cancel"/> | Returns to the previous settings. |

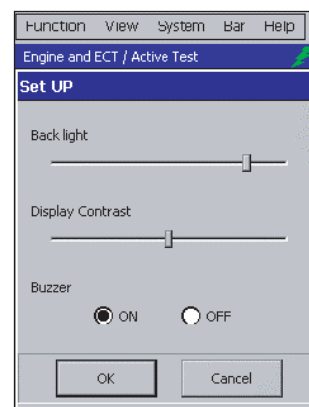

T00070E

Clock Functions (Date/Time)

The clock functions set the date and time.

The cursor is displayed and the item can be set when the desired item is touched.

Date

Sets the year /month/day.

Clock

Sets the hour:minute:second.

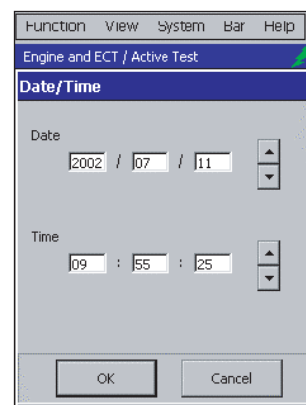

T00071E

◆ACTIVE KEY



Raises the value in the input column where the cursor is displayed.



Lowers the value in the input column where the cursor is displayed.

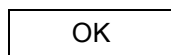

Activates the selected settings.

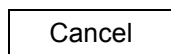

Returns to the previous settings.

Language Selection Function (Language Select)

The language selection function sets the use language for the Intelligent Tester II.

NOTE

- The Intelligent Tester II must be restarted to operate it in the selected language.



T00262E

◆ACTIVE KEY

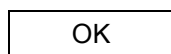

Activates the selected settings.

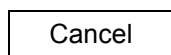

Returns to the previous settings.

Unit Conversion Function (Unit Conversion)

The unit conversion function sets the conversion units used with the Intelligent Tester II.

Units for the vehicle speed, temperature, pressure and air flow can be selected.

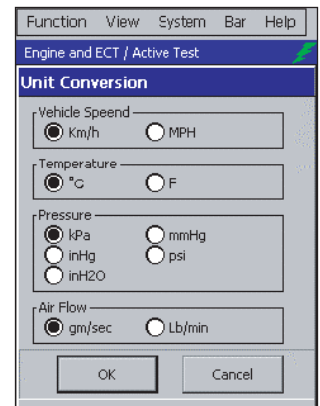

T00073E

◆ ACTIVE KEY

Activates the selected settings.

Returns to the previous settings.

Brand Selection Function (Brand Select)

The brand selection function sets the brand displayed on the opening screen when the Intelligent Tester II starts up.

Select from TOYOTA, LEXUS, or TOYOTA & LEXUS.

NOTE

- The brand selected for the opening screen can be checked the next time the Intelligent Tester II is started up.

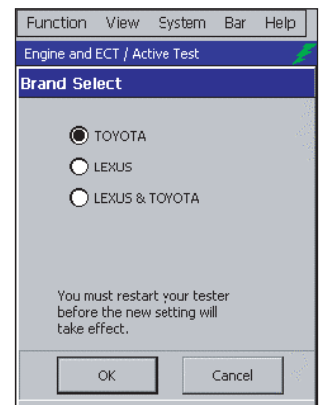

T00074E

◆ ACTIVE KEY

Activates the selected settings.

Returns to the previous settings.

Version Display Function (Version Information)

Version information for the Intelligent Tester II and for the applications used by the Intelligent Tester II can be checked using the version function.

The screen on the right is the Intelligent Tester II version information screen.

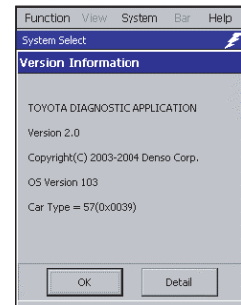

T00075E

The screen on the right is the detailed version information screen.

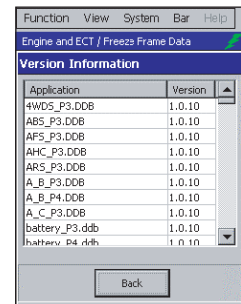

T00076E

◆ ACTIVE KEY

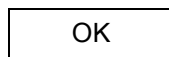

Activates the selected settings.

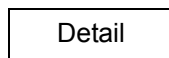

Displays the detailed version information screen enabling a check for application versions.

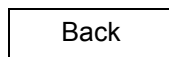

Returns the display to the previous screen.

Touch Panel Compensation Function (Screen Configuration)

The touch panel compensation function compensates for the deviation when a key is operated on the touch panel. The touch panel compensation procedure is as follows.

- 1.** Touch the + mark displayed in the center of the display.
The + mark moves to the top left of the display.
- 2.** Touch the new + mark that has moved.
The + mark moves to the bottom left of the display.
- 3.** Touch the new + mark that has moved.
The + mark moves to the bottom right of the display.
- 4.** Touch the new + mark that has moved.
The + mark moves to the top right of the display.
- 5.** Touch the new + mark that has moved.
The screen changes when the + mark disappears from the display.
- 6.** Touch any point on the display.
The display changes to the opening screen and touch panel compensation is complete.

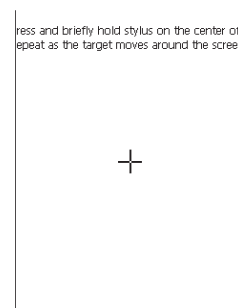

T00077E

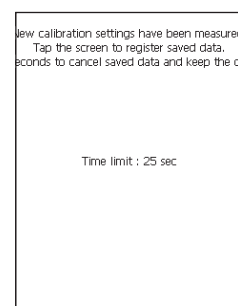

T01077E

NOTE

- When touching the + mark, always touch for at least one second. The + mark does not move unless touched it for at least one second.

Data Storage Setting Function (Memory Select)

The data storage setting function sets the storage location data.
Either internal memory or PC Card 1 can be selected.

- Internal Memory : Internal memory
- PC Card1: External memory card 1

The storage capacity is displayed after the data storage location has been selected.

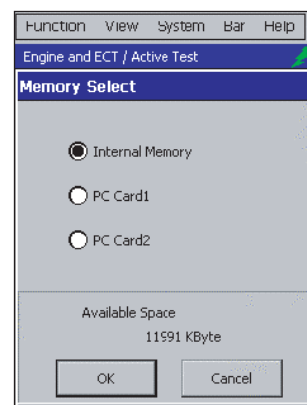

T00079E

◆ ACTIVE KEY

Activates the selected settings.

Returns to the previous settings.

Button Setting Functions (Button Configuration)

The button setting functions set short cuts to the left and right function keys on the main unit, and set image storage for the right function key.

- Short cut key settings determine where the screen returns to when the left or right function key on the main unit is pressed.
- The image storage setting switches the image storage function ON/OFF.
The image storage function can store the image being displayed as a file when the right function key on the main unit is pressed.
Up to 2 such image files can be stored. The 3rd image file will be written over the oldest file.
The image storage setting returns to the default value (OFF) when the Intelligent Tester II power goes OFF. This setting is always OFF immediately after the Intelligent Tester II starts up. To enable this function, you must set it to ON after startup.

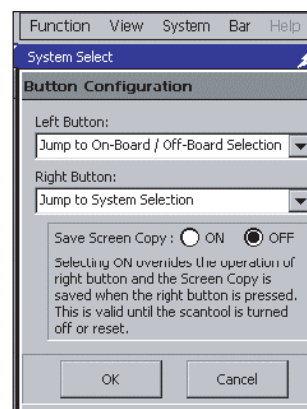

T00080E

◆ ACTIVE KEY

Activates the selected settings.

Returns to the previous settings.

4 Diagnostics Functions

4 Diagnostics Functions

The onboard/offboard check screen is displayed after the opening screen is displayed when the Intelligent Tester II starts up.

When or is touched on the onboard/offboard check screen, the Intelligent Tester II begins communication with the vehicle and check the ECU. To execute measurement functions such as the oscilloscope that do not require communication with the vehicle, touch .P.55

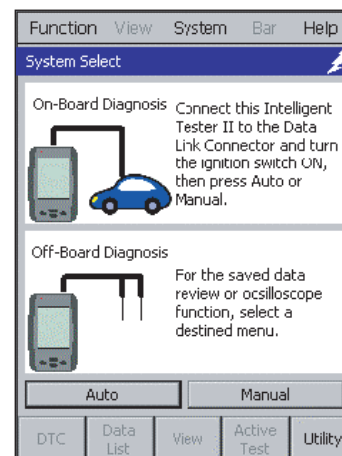

T00081E

Onboard/offboard check screen

NOTE

- If you execute the OBD function when the vehicle battery is 8V or less, the ABS lamp may come on, depending on the vehicle. A warning screen like the one shown on the right will appear. Recharge or replace the battery and execute the OBD function again.

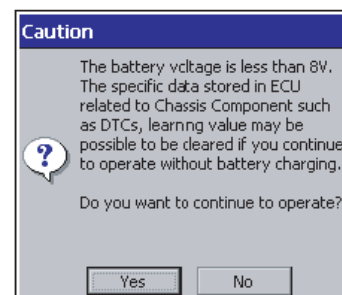

T00082E

Warning screen

System Selection

It is necessary to select the diagnostics system (the system within the vehicle) when diagnosing the vehicle. The procedure for selecting the system is as follows.

NOTE

- The screen on the right may appear before selecting the system procedure. Select the vehicle to be diagnosed.

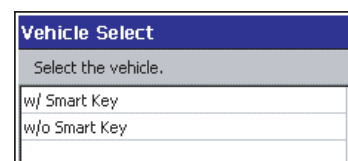

T00083E

Vehicle select screen

Automatic Vehicle Selection

1. Touch the list box on the system select screen to select the system category.

When the vehicle information is acquired from the vehicle computer (ECU), the system select screen is displayed. Select powertrain, chassis, or body as the system category.

A list of the vehicle mounted systems being diagnosed is then displayed. If vehicle information cannot be acquired, a message screen is displayed.

NOTE

- If a message screen appears, touch **OK** to close the window. Touch **Manual** on the onboard/offboard check screen and select the vehicle to be diagnosed.

Manual Vehicle Selection

1. Enter the data on the vehicle data input screen to specify the vehicle to be diagnosed.

When you touch each data button, a data select screen is displayed.

Select the data of the vehicle to be diagnosed from the data select screen.

Touch **OK** and the system select screen is displayed.

Operation from this point is the same as when selecting an automatic vehicle.

NOTE

- The Intelligent Tester II communicates with the vehicle computer (ECU) even in the case of Manual Vehicle Selection. Connect the Intelligent Tester II with the vehicle before touching **Manual**.

Reference: Page 14 Connecting to the Vehicle (Chapter 1. Before Use/Connection)

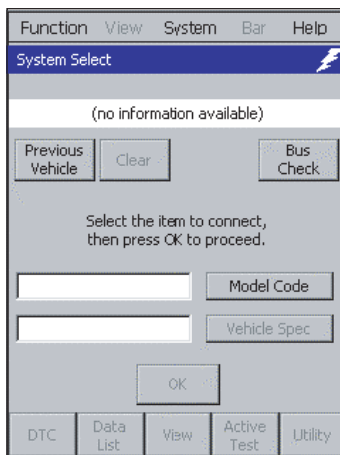

Vehicle data input screen

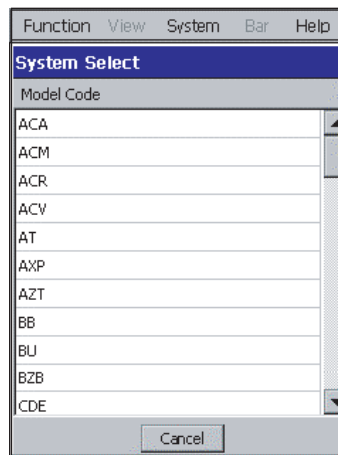

Data select screen

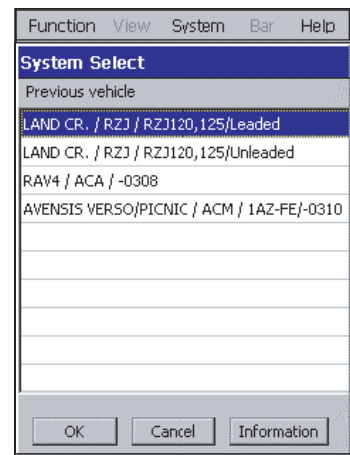

Previous vehicle select screen

◆ **ACTIVE KEY**

Previous Vehicle

You can select the manual select data of the previous ten selected vehicles.

2. Touch the system to undertake diagnosis from the system list.

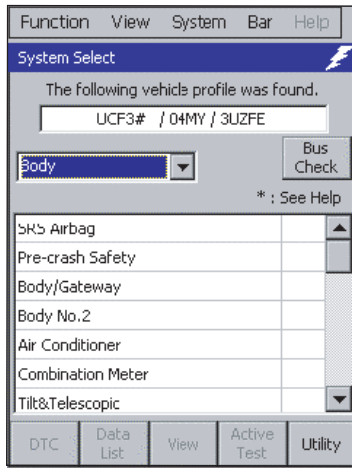

System select screen

T00087E

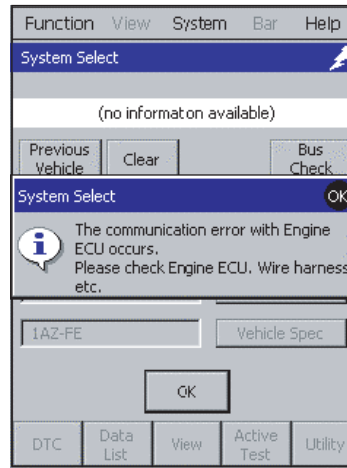

Message screen

T00088E

NOTE

- When you select the system, a warning screen like the one shown on the right may be displayed. Make sure you understand the message displayed before carrying out vehicle diagnosis.

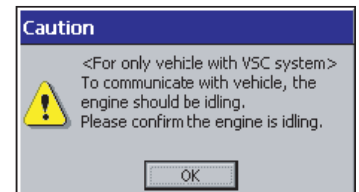

Warning screen

T00089E

NOTE

- After the Intelligent Tester II is started, the system select screen is displayed. To reselect a system after having moved to other processing, press the right function key on the main unit or select the menu bar [Function] menu list -> [System Select]. This displays the system select screen.

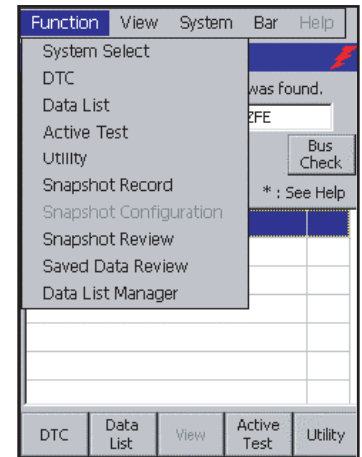

[Function]Menu list

T00090E

◆ **ACTIVE KEY**

Bus Check Starts the CAN bus check.

DTC Check

DTC data is data stored in the vehicle computer (ECU) internal memory when a trouble occurs. Checking DTC data can aid in specifying the cause of the trouble.

DTC Data Display

Displays the DTC data for the system selected on the system select screen. The procedure for displaying the DTC data is as follows.

1. Select the system from the system select screen.
2. Touch the **DTC** main menu button.
Alternatively, touch [DTC] in the system select screen [Function] list.
The DTC data list is displayed on the DTC data display screen.

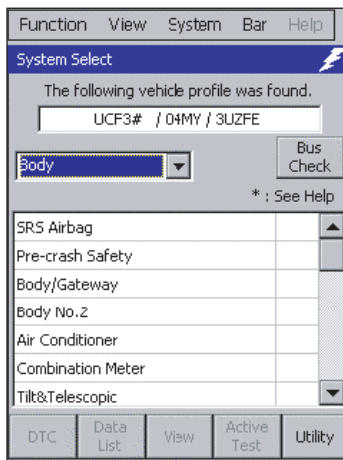

System select screen

T00091E

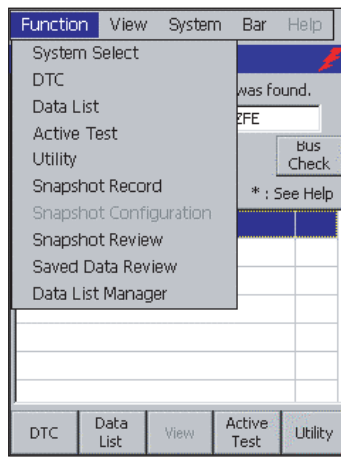

[Function] Menu list

T00092E

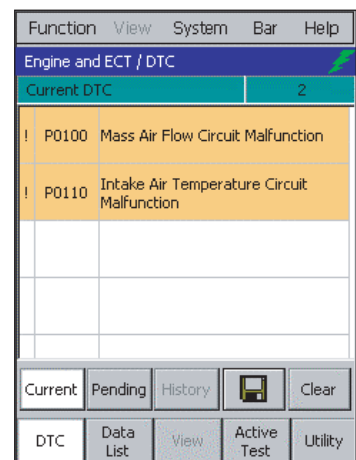

DTC data display screen

T00093E

NOTE

- A "!" displayed at the left of DTC data shown in orange means that freeze frame data has been recorded for that data.

Reference: Page 50 Freeze Frame Data Display (Chapter 4. Diagnostics Functions/DTC Check)

◆ACTIVE KEY

Current Displays the current DTC data.
When there is DTC data, this button is displayed in blue.

Pending Displays pending DTC data.
When there is pending DTC data, this button is displayed in blue.

History Displays historical DTC data (past codes).
When there is historical DTC data, this button is displayed in blue.

 Saves DTC data. *Reference: Page 47*

Clear Clears the DTC data stored in the vehicle computer (ECU). *Reference: Page 49*

DTC Data Storage

DTC data can be stored. The factory setting for the data storage destination is the internal memory. The data storage destination can be changed using the data storage setting function.

Reference: Page 41 Data Storage Setting Function (Memory Select) (Chapter 3. Default Settings/Tool Option Function)

The procedure for saving the DTC data is as follows.

1. From the DTC data display screen function buttons, touch  .

The DTC data save screen is displayed.

2. The set file name is displayed on the DTC data save screen.

If this file name is correct, touch  .

To save to a different file, input the name of that file, and then touch  .

Reference: Page 30 Software keyboard operation (Chapter 2. Basic Operations/Basic Operations/Display Operation)

The first time this screen is displayed, "Vehicle model_model year_serial number" is set automatically as the file name displayed.

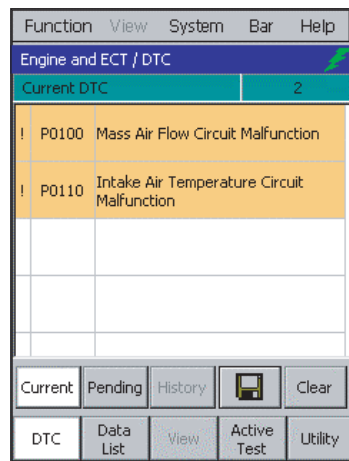

DTC data display screen

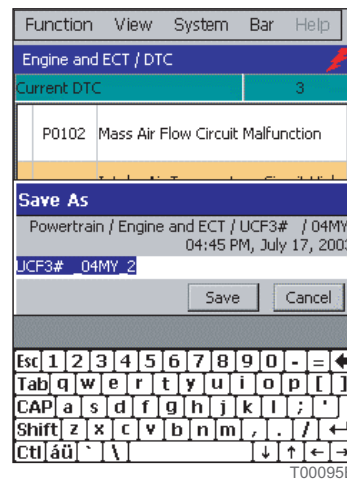

DTC data save screen

◆ACTIVE KEY

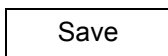

Saves DTC data.

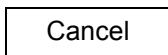

Cancels DTC data saving.

NOTE

- The stored DTC data can be played back at any time. The Intelligent Tester II does not need to be connected to the vehicle for playback.

Reference: Page 82 DTC Playback (Chapter 5. Saved Data Playback Functions)

- If the storage memory is full, the DTC data delete verification dialog box is displayed and unnecessary DTC data can be deleted.

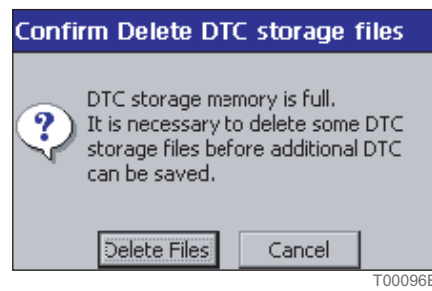

DTC data delete verification dialogue

◆ ACTIVE KEY

Displays a list of stored data.

Cancels DTC data deletion.

DTC Data Clear

The procedure for clearing the DTC data is as follows.

1. From the DTC data display screen function buttons, touch **Clear** .
The DTC data clear dialog box is displayed.
2. On the DTC data clear dialog box, touch **Yes** .
Delete DTC data by following the operating instructions on the screen.

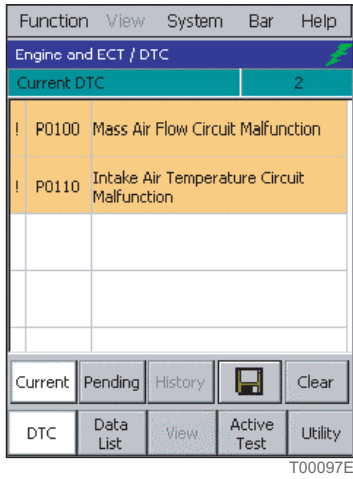

T00097E
DTC data display screen

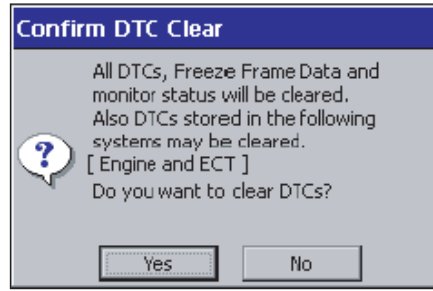

T00098E
DTC data clear dialog box

NOTE

- A Vehicle data input screen is displayed with certain vehicles. Follow the instructions on the screen.



T00099E
Vehicle data input screen

Freeze Frame Data Display

Displays freeze frame data related to the DTC data.

There are two types of freeze frame data:

- Single freeze frame data : ECU data recorded when the DTC data is generated.
- Multi freeze frame data : ECU data recorded when the DTC data is generated and before and after it is generated.

The procedure for displaying freeze frame data is as follows.

1. On the DTC data display screen, touch the DTC data displayed in orange with "!" to the left.

NOTE

- A "!" displayed to the left of DTC data shown in orange indicates that freeze frame data has been recorded for that data.

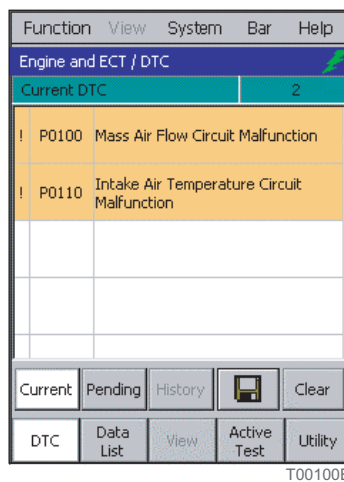

T00100E
DTC data display screen

The single freeze frame data display screen is displayed for single freeze frame data. The multi freeze frame data display screen is displayed for multi freeze frame data.

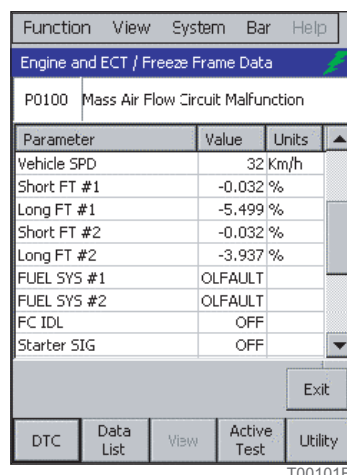

T00101E
Single freeze frame data display screen

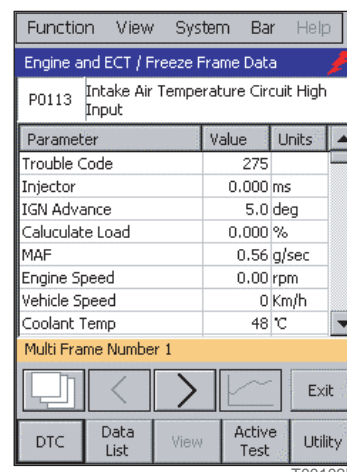

T00102E
Multi freeze frame data display screen

Single freeze frame data display

The single freeze frame data display screen is displayed for single freeze frame data.

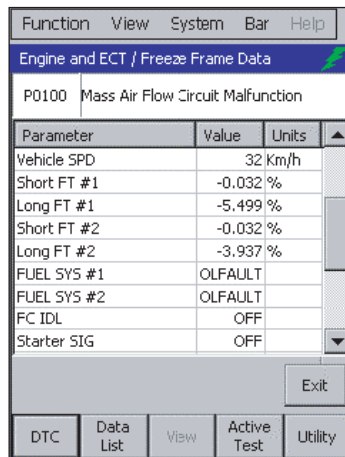

T00103E

Single freeze frame data display screen

◆ ACTIVE KEY

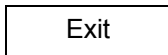

Returns the display to the DTC data display screen.

Multi freeze frame data display

The multi freeze frame data display screen is displayed for multi freeze frame data.

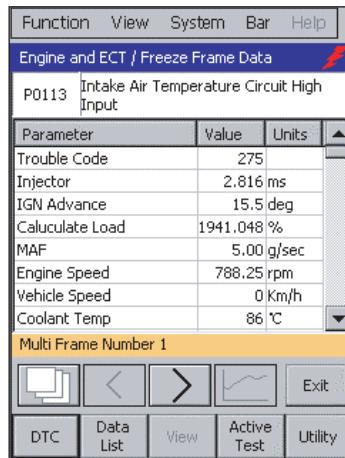

T00104E

Multi freeze frame data display screen

The Multi Frame Number for multi freeze frame data currently being displayed is shown in orange. The Multi Frame Number is a serial number.

◆ ACTIVE KEY



Displays a screen showing a list of time series data.

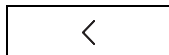

Displays the data for the previous frame.

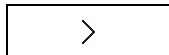

Displays the data for the next frame.



Displays a graph of the data history selected on the multi freeze frame data display screen. This is not valid unless an item has been selected.

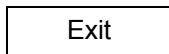

Returns the display to the DTC data display screen.

- Touching  on the multi freeze frame data display screen displays a screen showing a list of time series data for the displayed multi freeze frame data.

Param...	-3	-2	-1	0	1
IGN Advan	15.5	15.5	18.5	16.5	14
Caluculate	11.048	33.205	38.627	30.784	32.3
MAF	5.00	5.04	0.50	0.50	0.!
Engine Spe	788.25	795.25	521.75	508.50	194.!
Vehicle Spe	0	0	0	0	
Coolant Te	86	86	86	86	
Intake Air	55	55	-40	-40	--
Air-Fuel Ra	10.100	10.100	10.100	10.100	14.3

T00105E

Time series data list display screen

◆ ACTIVE KEY



Returns the display to the multi freeze frame data display screen.

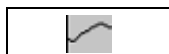

Displays a graph of the data history selected on the time series display screen. This is not valid unless an item has been selected.

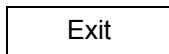

Returns the display to the DTC data display screen.

Multi freeze frame data graph display

When data is selected on the multi freeze frame data display screen or the time series display screen and then  is touched, a multi freeze frame data graph screen is displayed.

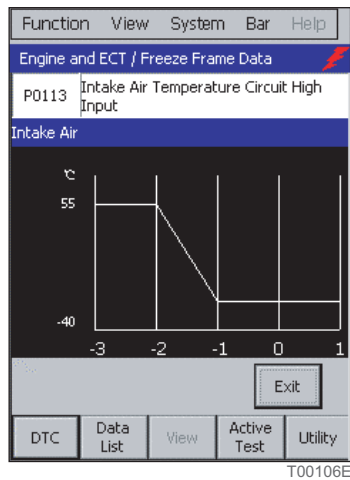

Multi freeze frame data graph screen

◆ ACTIVE KEY

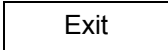
 Returns the display to the previous screen.

Data List

Vehicle computer (ECU) data can also be monitored numerically or in graph form and snapshots can be recorded.

Data List Display

Displays the ECU data for the system selected on the system select screen.
The procedure for displaying the ECU data is as follows.

1. Select the system with the system select screen.
2. Touch the **Data List** main menu button.
Alternatively, touch [Data List] in the system select screen [Function] menu list.
ECU data is displayed on the data list screen.

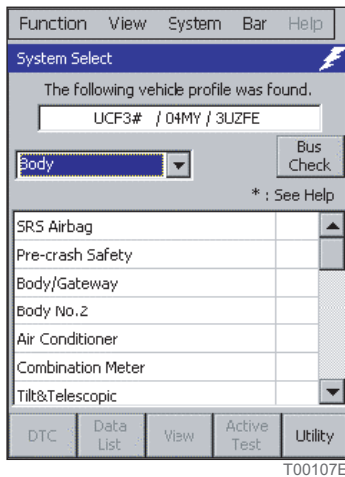

System select screen

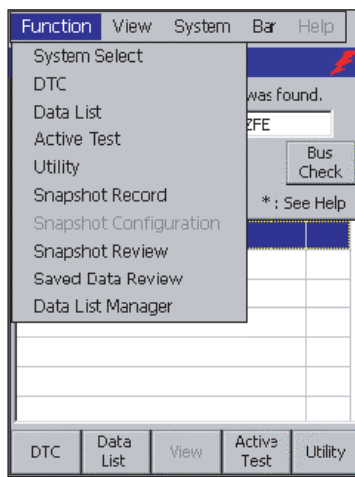

[Function] menu list

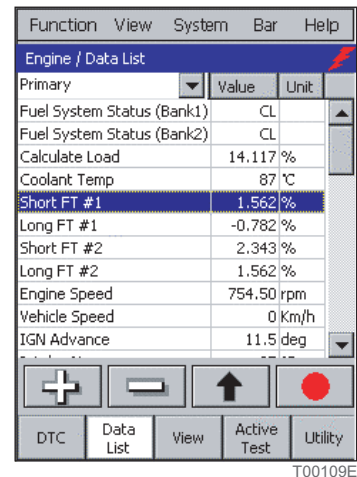

Data list screen

Measurement group selection

Data required for diagnosing a specific breakdown can be grouped.

The ECU data belonging to a measurement group can be displayed by selecting that group.

1. From the data list screen list box, select the measurement group.

When you select a measurement group, the ECU data belonging to that group is displayed.

Function	View	System	Bar	Help
Engine / Data List				
Primary		Value	Unit	
Fuel System Status (Bank1)		CL		
Fuel System Status (Bank2)		CL		
Calculate Load		14.117 %		
Coolant Temp		87 °C		
Short FT #1		1.562 %		
Long FT #1		-0.782 %		
Short FT #2		2.343 %		
Long FT #2		1.562 %		
Engine Speed		754.50 rpm		
Vehicle Speed		0 Km/h		
IGN Advance		11.5 deg		

T00110E

Data list screen

Function	View	System	Bar	Help
ABS/TRC/VSC / Data List				
All Data		Value	Unit	
All Data		OFF		
Custom List		OFF		
ABS_Relay Status		3 deg		
ABS_Sensor Monitor		760 rpm		
ABS_Sensor Status		0 km/h		
ABS_Solenoid Status		-1 deg/s		
ABS_Vehicle Speed Informa		-1 deg/s		
Diagnosis				
Steering sensor		1150 deg		
Master Cylinder Sensor1		0.49 V		
PPS solenoid		OFF		
Test mode operation		Normal		

T00111E

Measurement group select screen

◆ ACTIVE KEY



Starts the data list manager and adds the displayed data. [Reference: Page 71](#)



Ends display of the selected data.
This is not valid unless data has been selected.



Moves the selected data to the head of the list and holds it there.
This is not valid unless data has been selected.



Returns the data held at the head of the list to its original position.
When the held data is selected, changes to .



Records a snapshot. [Reference: Page 65](#)

Display Switching

Display form

There are seven data list display formats.
These display formats are shown below.

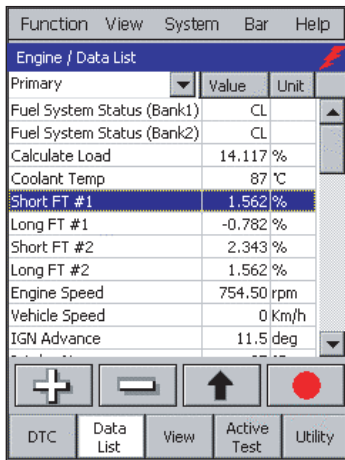

Data List 1

T00112E

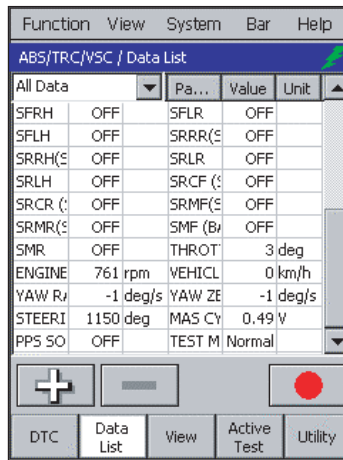

Data List 2

T00113E

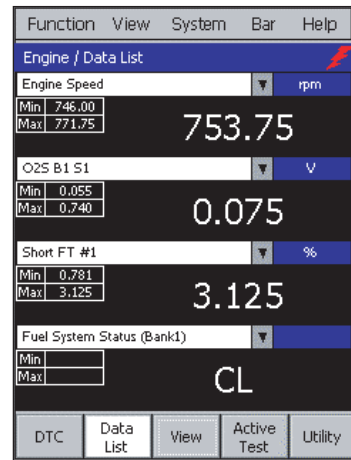

Meter 1

T00114E

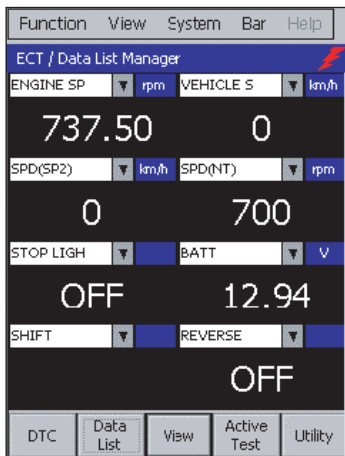

Meter 2

T00115E

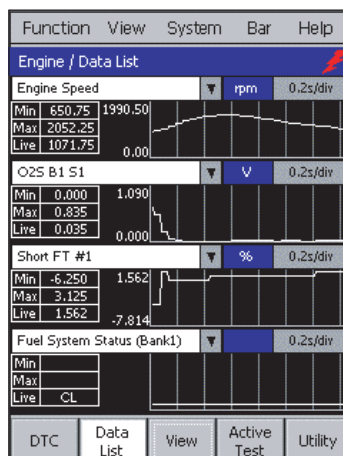

Line Graph 1

T00116E

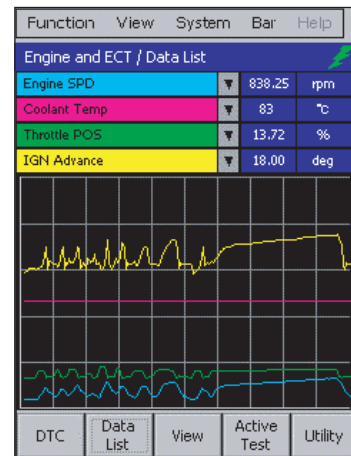

Line Graph 2

T00117E

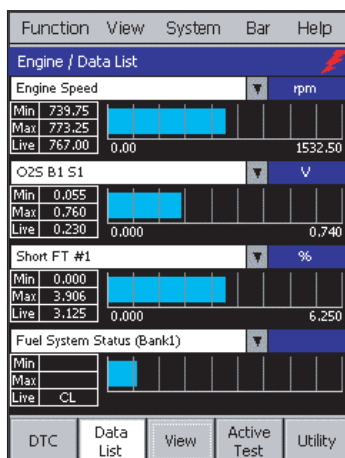

Bar Graph

T00118E

- Display of maximum, minimum and current values
If the display forms are Meter 1, Line Graph 1 and Bar Graph, the maximum, minimum and current values are displayed to the left of the data.
They are not displayed if the value is not a number e.g. ON/OFF.

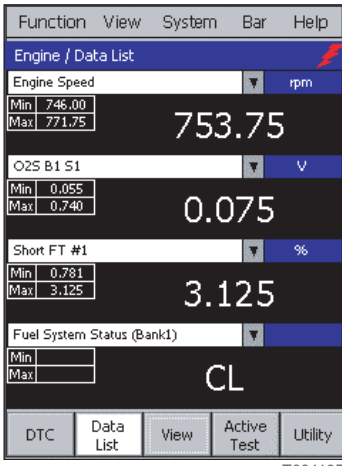

Meter 1 T00119E

Display format switching

The following two methods can be used to switch the display format.

- Select the display format by touching the main menu **View**.
Each time **View** is touched, the display form switches to the next type in the following order:
Data List 1-> Meter 1-> Line Graph 1-> Line Graph 2-> Bar Graph.



Main Menu Buttons T00120E

- Select from the menu bar **[View]** menu.

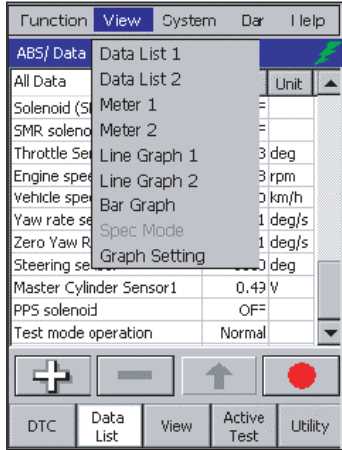

[View] menu T00121E

Data List 1

Data List 1 (number display) displays the data numerically.

- A measurement group can be selected with the list box.
- You can switch the function button display on and off by touching [Bar] on the menu bar.

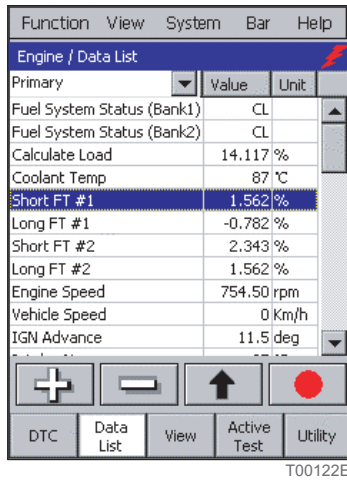

Data List 1

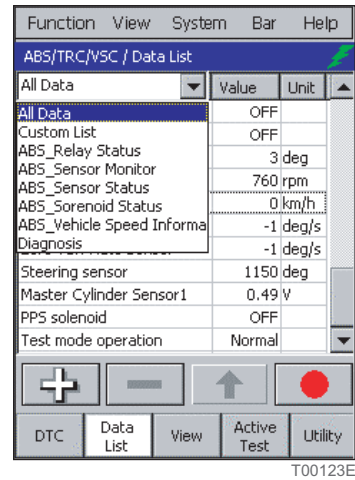

With the list box pulled down

◆ ACTIVE KEY



Starts the data list manager and adds the displayed data. [Reference: Page 71](#)

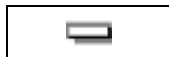

Stops display of the selected data.
This is not valid unless data has been selected.



Moves the selected data to the head of the list and holds it there.
This is not valid unless data has been selected.



Returns the data held at the head of the list to its original position.
When the held data is selected, changes to .



Records a snapshot. [Reference: Page 65](#)

Data List 2

Data List 2 (compressed number display) uses abbreviations for the data names and displays twice as many data items as Data List 1.

- A measurement group can be selected using the list box.
- The function button display can be switched on and off by touching [Bar] on the menu bar.

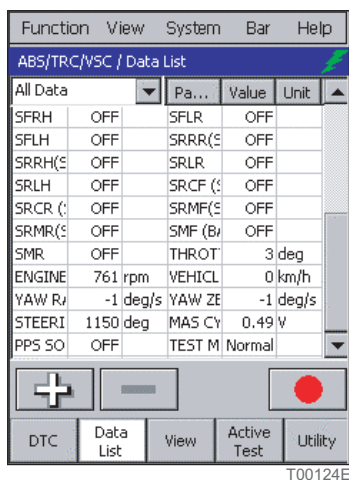

Data List 2

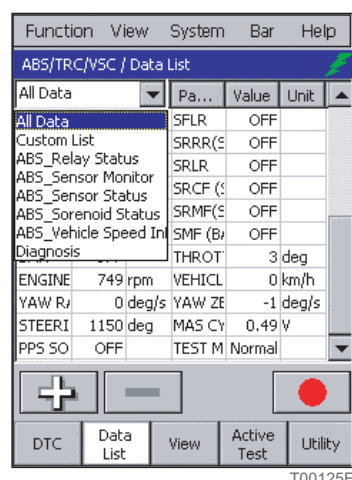

With the list box pulled down

◆ ACTIVE KEY



Starts the data list manager and adds the displayed data. [Reference: Page 71](#)

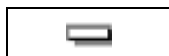

Ends display of the selected data. This is not valid unless data has been selected.



Records a snapshot. [Reference: Page 65](#)

Meter 1

Meter 1 (enlarged number display) displays the data as enlarged numbers.

- The maximum and minimum values are displayed.
- The data for display can be selected using the list box.
- The function button display can be switched on and off by touching [Bar] on the menu bar.

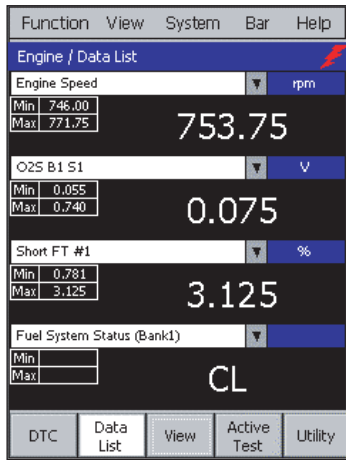

Meter 1



When the [Bar] menu is touched

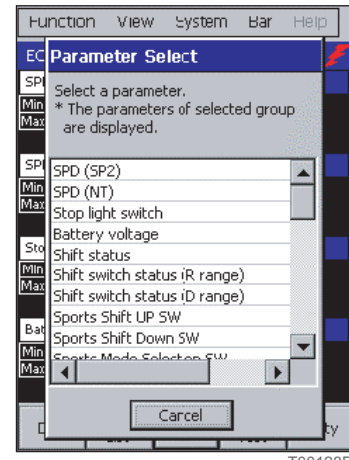

With the list box

◆ ACTIVE KEY



Switches the buzzer that sounds when the "Max" or "Min" value or the line graph vertical axis (value) is updated ON/OFF.

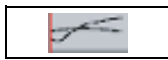

Sets the line graph horizontal axis (time).



Records a snapshot. [Reference: Page 65](#)

Meter 2

Meter 2 (compressed enlarged number display) uses abbreviations for the data names and displays twice as many data items as Meter 1.

- The data for display can be selected using the list box.
- The function button display can be switched on and off by touching [Bar] on the menu bar.

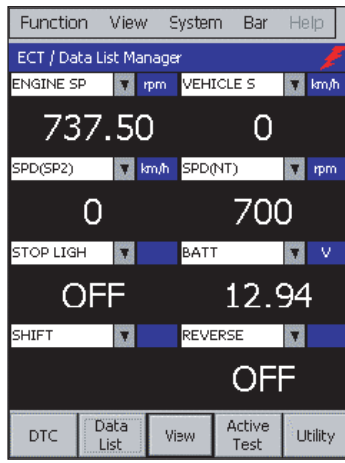

Meter 2

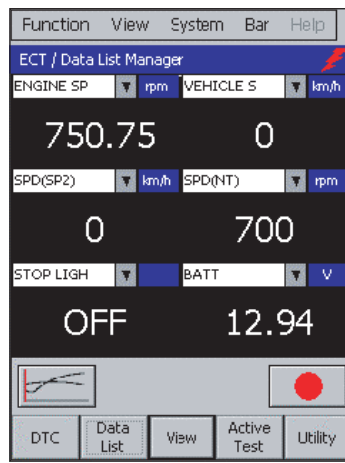

When the [Bar] menu is touched

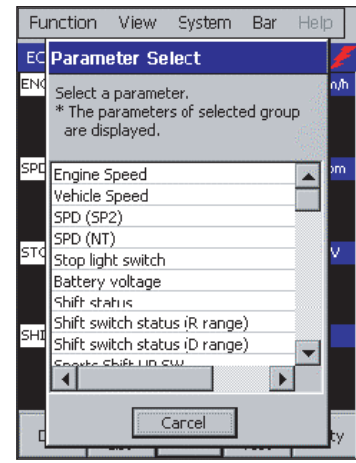

With the list box

◆ ACTIVE KEY

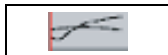

Switches the buzzer that sounds when the "Max" or "Min" value is updated ON/OFF.



Records a snapshot. [Reference: Page 65](#)

Line Graph 1

Line Graph 1 displays the data as a line graph.

- The maximum and minimum values are displayed.
- The current values of the data are displayed.
- Data can be selected using the list box.
- The function button display can be switched on and off by touching [Bar] on the menu bar.

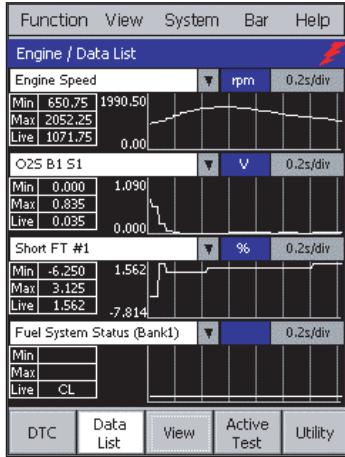

Line Graph 1

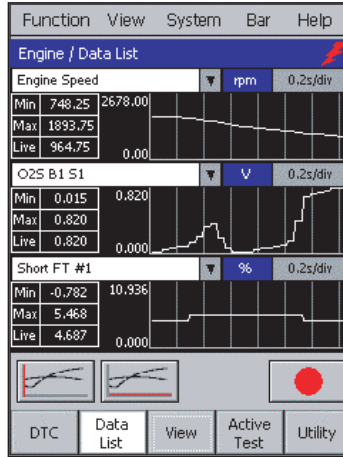

When the [Bar] menu is touched

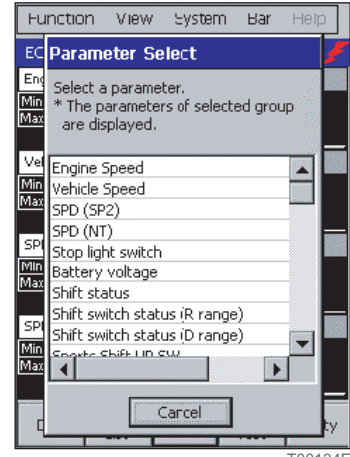

With the list box

◆ ACTIVE KEY



Switches the buzzer that sounds when the "Max" or "Min" value or the line graph vertical axis (value) is updated ON/OFF.



Sets the line graph horizontal axis (time).



Records a snapshot. [Reference: Page 65](#)

Line Graph 2

Line Graph 2 (line graph combined display) displays multiple data sets as a line graph on the same axis.

- Data can be selected using the list box.
- The function button display can be switched on and off by touching [Bar] on the menu bar.

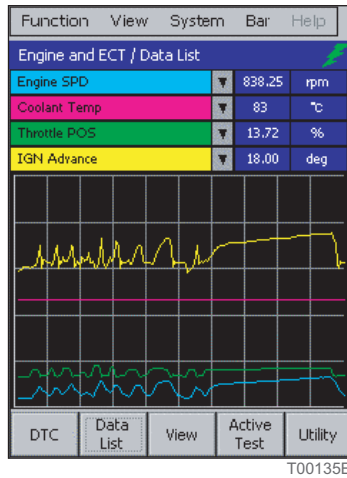

Line Graph 2

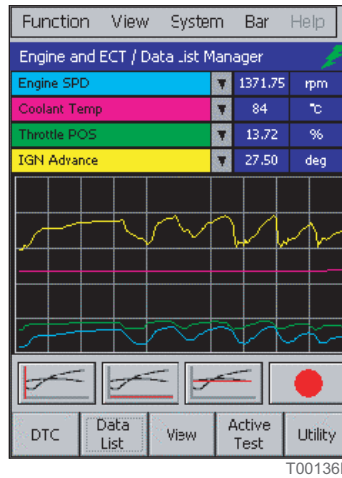

When the [Bar] menu is touched

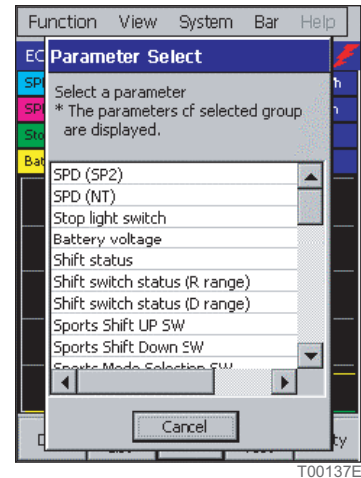

With the list box

◆ ACTIVE KEY



Switches the buzzer that sounds when the "Max" or "Min" value or the line graph vertical axis (value) is updated ON/OFF.



Sets the line graph horizontal axis (time).

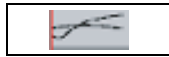

Sets the ground position for the selected data.



Records a snapshot. [Reference: Page 65](#)

Bar Graph

This function displays the data as a bar graph.

- Data can be selected using the list box.
- The function button display can be switched on and off by touching [Bar] on the menu bar.

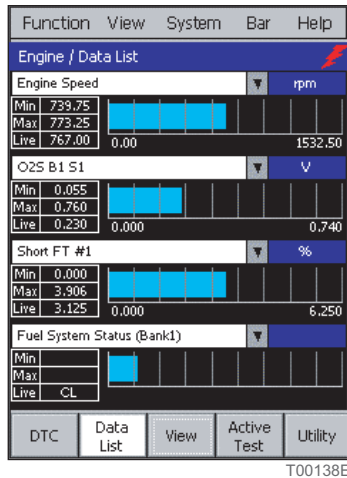

Bar Graph

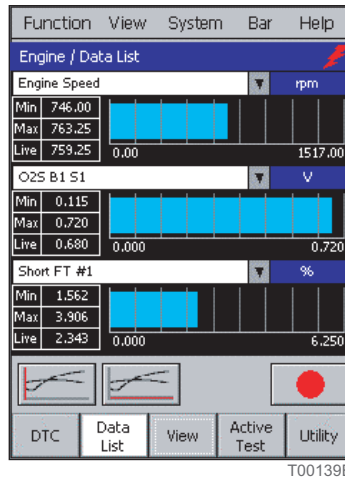

When the [Bar] menu is touched

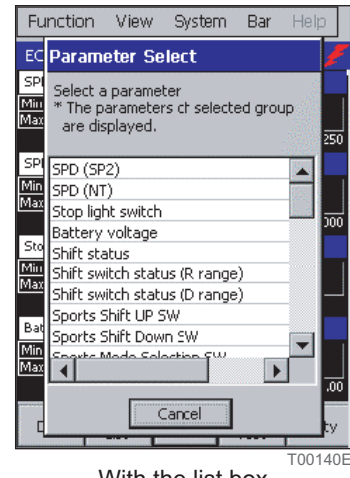

With the list box

◆ ACTIVE KEY



Switches the buzzer that sounds when the "Max" or "Min" value or the line graph vertical axis (value) is updated ON/OFF.



Sets the line graph horizontal axis (time).



Records a snapshot. [Reference: Page 65](#)

Snapshots

Data in the data list can be recorded/saved/played back. In addition, settings can be performed for snapshot operation.

Snapshot recording/saving

The procedure for recording/saving snapshots is as follows.

1. Touch the  function button.
Alternatively, in the data list screen [Function] menu list, touch [Snapshot Record].
The snapshot record/save screen is displayed.

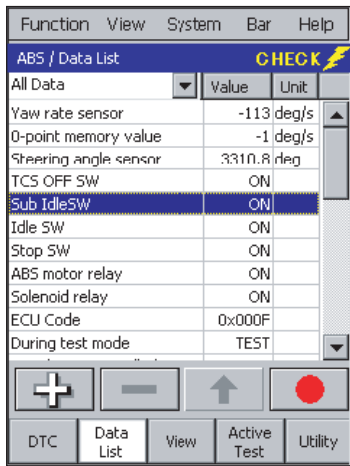

Data list screen

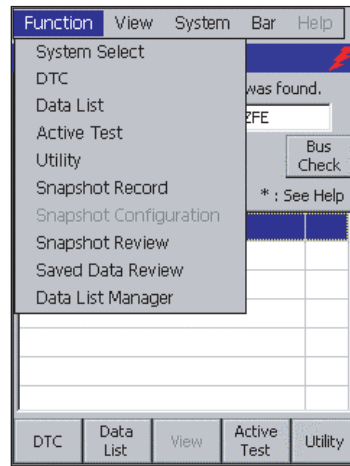

[Function] menu list

2. Data recording/saving starts automatically.

When the data recording/saving ends, the system goes into playback/new recording standby mode.

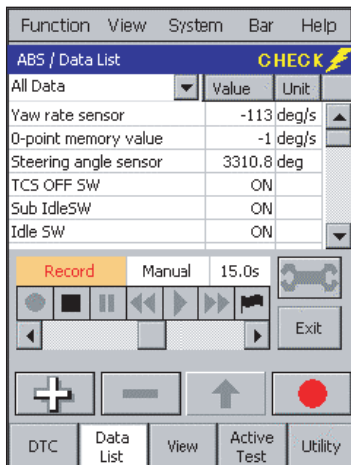

When recording



When saving

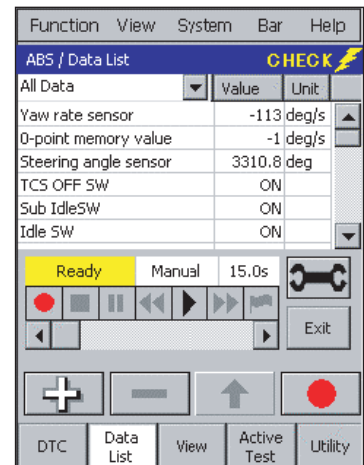

Playback/new recording standby

- "Vehicle model_model year_serial number" is set automatically as the file name saved.
- You can set the snapshot flag by touching [] when recording.

NOTE

- The snapshot flag stores the point as a mark for the data time elapsed. During playback, you can move quickly to points using the snapshot flags.
- Up to five snapshot flags can be set.

Reference: Page 86 Playback With Snapshot Flag Set (Chapter 5. Saved Data Playback Functions/Snapshot Playback)

◆ ACTIVE KEY

Sets snapshot operations. *Reference: Page 68*

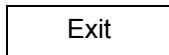

Ends the snapshot.



Stops recording/playback and returns to the start of the data.



Recording starts.



Playback starts.



Sets a snapshot flag.

How to use the optional accessory Trigger Snapshot

Connecting the Trigger Snapshot

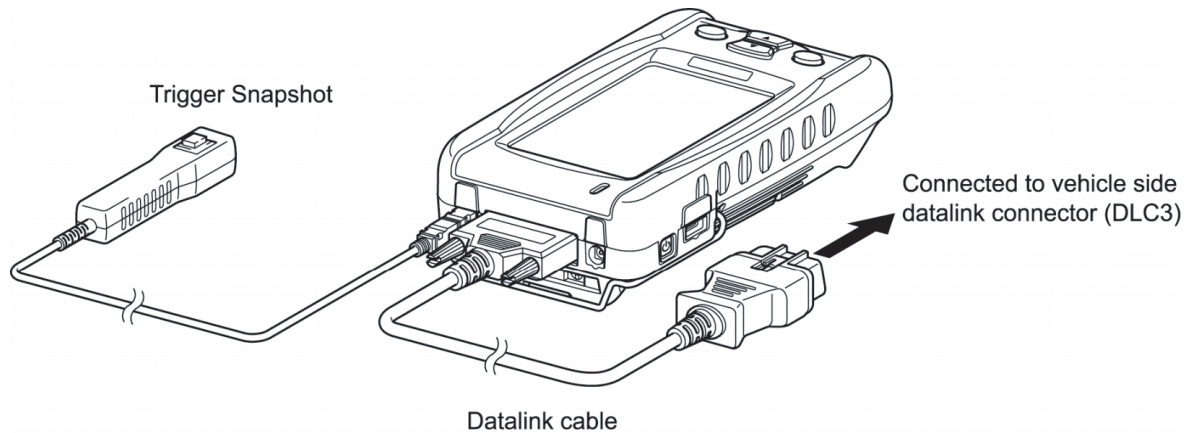

T00146E

CAUTION

- When connecting the probe to the Intelligent Tester II, gently insert it straight into the connector. Inserting the probe at a slant can break the connector pins.

How to use Trigger Snapshot

- 1.** Press the Trigger Snapshot button while the data list is displayed.
Data recording begins.
- 2.** Press the Trigger Snapshot button during data recording.
A snapshot flag is set.

NOTE

- Trigger Snapshot can be used to set snapshot flags in a maximum of five places.
Reference: Page 86 Playback With Snapshot Flag Set (Chapter 5. Saved Data Playback Functions/Snapshot Playback)
- Pressing the Trigger Snapshot button after five snapshot flags are set stops data recording.

Snapshot operation settings

Settings can be performed for snapshot operation.

1. Touch  on the snapshot screen.
Alternatively, in the data list screen [Function] list, touch [Snapshot Configuration].
The snapshot operation setting screen is displayed.

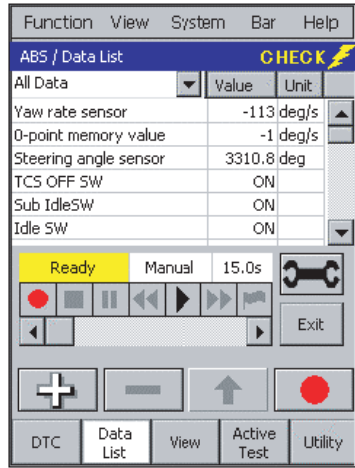

Snapshot screen

T00147E

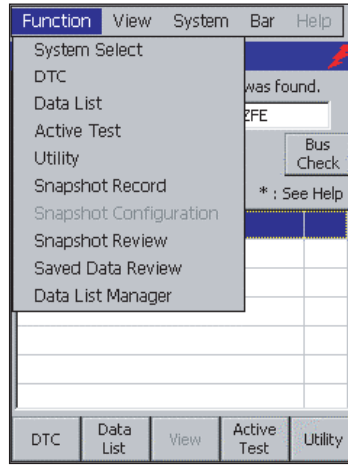

[Function] Menu list

T00148E

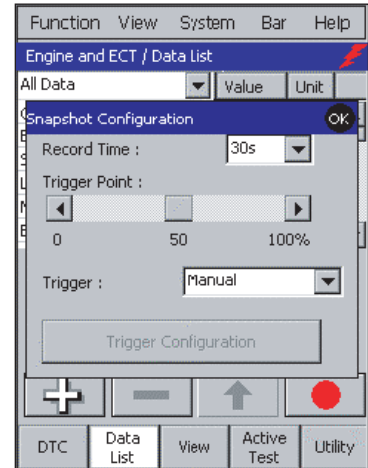

Snapshot operation setting screen

T00149E

The setting contents are as follows.

- Record Time
Sets the recording time.
Select from 5s/10s/15s/30s/1 min./2 min./5 min.
- Trigger Point
Sets the percentage of the recording time saved as data before the trigger is pressed.
- Trigger
Sets the type of trigger. The types of triggers are as follows.
 - Manual : The trigger is applied manually by touching the data list display section.
 - Parameter : The trigger is applied at the set parameter value.
 - DTC : The trigger is applied when a diagnostics code is detected.
 - MIL : The trigger is applied when the engine warning lamp comes ON.
- Trigger Configuration Button
Sets the parameter triggers. This button is only active if “Parameter” is selected from the trigger items.
Reference: Page 69

Parameter trigger setting

Detailed settings can be performed related to the parameter triggers.

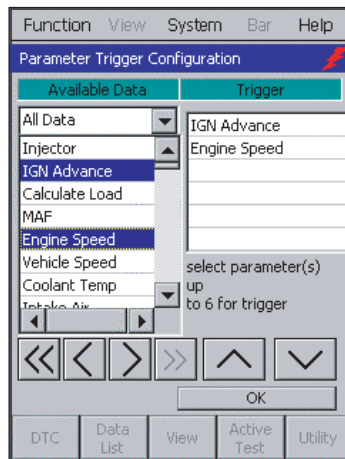

Trigger data selection screen

◆ ACTIVE KEY

- >

Adds only the data selected in the item list to the Trigger list.
- <<

Deletes all the data in the Trigger list.
- <

Deletes only the data selected in the Trigger list.
- ^

Moves the data selected in the Trigger list up one space.
- v

Moves the data selected in the Trigger list down one space.
- OK

Displays the Parameter trigger level setting screen.

Parameter trigger level setting

Detailed settings can be performed related to the level of parameter triggers.

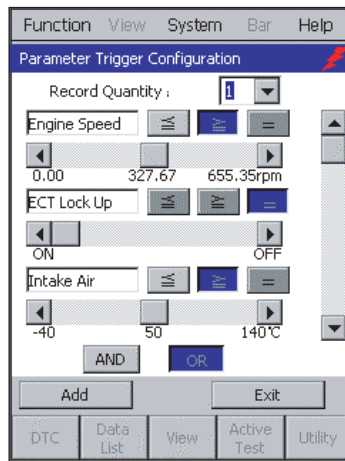

Value setting screen

● Record Quantity : Sets the number of times snapshot is repeated.

◆ ACTIVE KEY

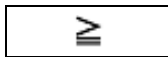

Applies the trigger when the ECU data is higher than or equal to the set value.

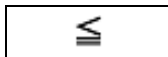

Applies the trigger when the ECU data is lower than or equal to the set value.

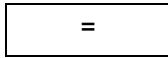

Applies the trigger when the ECU data equals the set value.



Sets the trigger level.

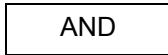

Applies the trigger when all set conditions are satisfied.

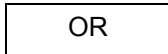

Applies the trigger when some of the set conditions are satisfied.

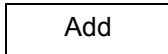

Returns to the trigger data selection screen. (Trigger data can be added.)

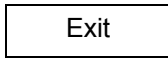

Returns to the Snapshot operation setting screen.

Data List Manager

With the data list manager, you can change display data lists and other data set in measurement groups and create new measurement groups.

The procedure for starting the data list manager is as follows.

1. To change the display data, select the related measurement group on the data list screen.
2. In the data list screen [Function] menu, touch [Data List Manager]. Or touch the  function button.

The data list manager screen is displayed.

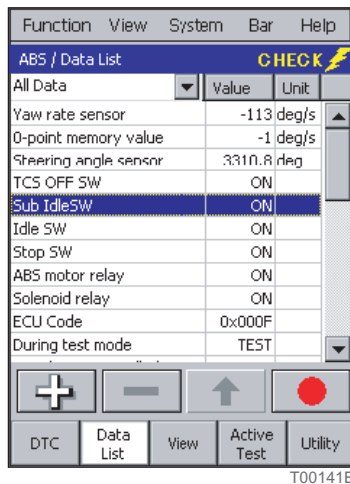

Data list screen

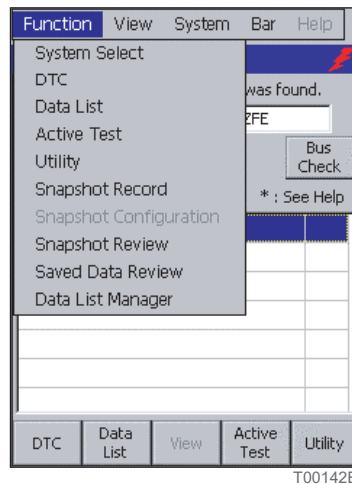

[Function] menu list



Function buttons

3. Change the display data on the data list manager screen.

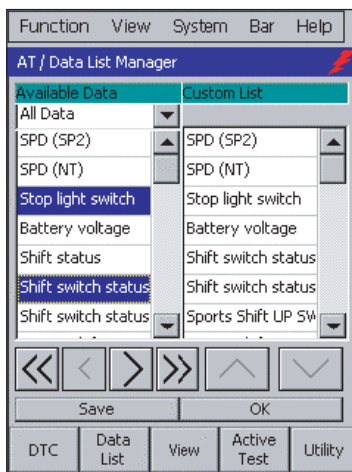

With the display data selected

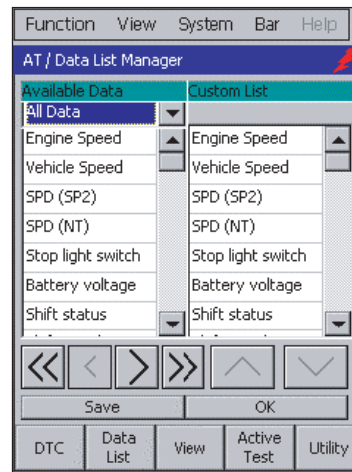

When the display data is decided

◆ ACTIVE KEY

- | | |
|------|--|
| > | Adds only the data selected in the item list to the custom list. |
| >> | Adds all the data in the item list to the custom list. |
| << | Deletes all the data in the custom list. |
| < | Deletes only the data selected in the custom list. |
| ^ | Moves the data selected in the custom list up one space. |
| v | Moves the data selected in the custom list down one space. |
| Save | Sets the custom list data. |
| OK | Returns the display to the previous screen. |

Help function

When [Help] is touched in the menu bar, the help screen is displayed and guidance concerning the data list is shown. To close the help screen, touch [OK] at the top right of the screen.

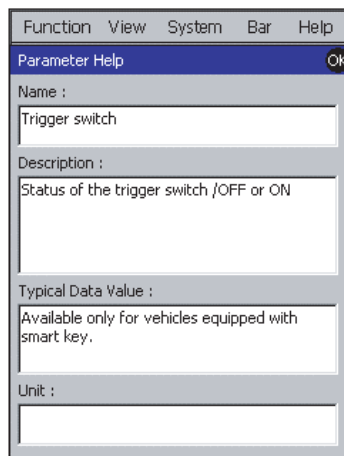

Help screen

T00158E

Active Test

The active test is a function to forcibly drive relays, actuators, solenoids, etc.

If they are driven normally in the active test, it is possible to judge circuits as normal from the ECU to relays, actuators, solenoids, etc.

Active Test Item Selection

Selects the active test items.

- From the main menu buttons, touch **Active Test** .
Alternatively, from the [Function] menu list, touch [Active Test].
The active test item select screen is displayed.
- On the active test item select screen, select the test items and then touch **Enter** .
The active test starts.



Main menu buttons

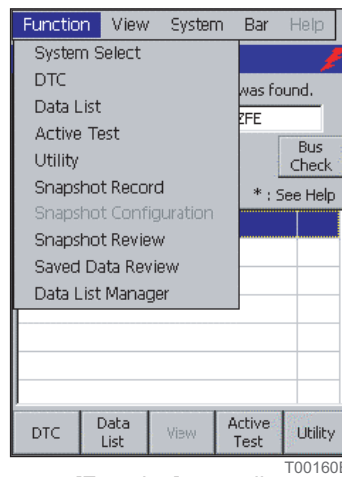

[Function] menu list

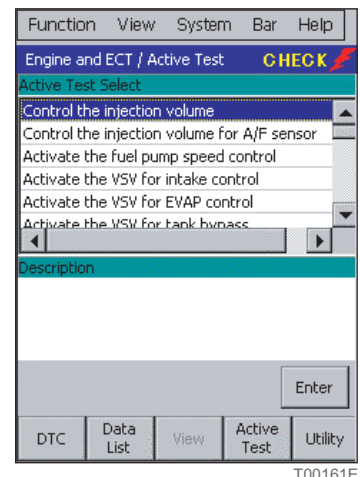

Active test item select screen

◆ ACTIVE KEY

- Enter** Starts the active test for the selected items.
This is not valid unless a test item has been selected.

Active Test Execution

Actuators are driven by the control box.

During an active test, the data list can be displayed simultaneously and measurement groups selected from the list box.

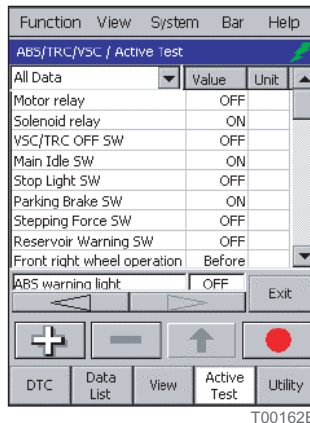

Active test execution screen

NOTE

- No data list can be displayed during an active test according to the ECUs selected (ABS, etc.).

Control box

When an active test is executed, the control box for varying the drive value is displayed under the test item, so it is possible to set the active test drive value.

There are three types of control box as follows, and the system switches automatically among them according to the test items selected.

- Binary type

The drive value is varied between two values (ON/OFF, etc.).

- Digital change type

The drive value is changed digitally.

- Analog change type

The drive value is changed in analog.

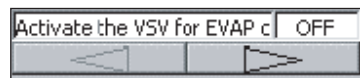
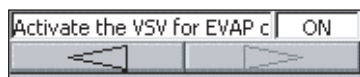

T00163E

Binary type



T00164E

Digital change type



T00165E

Analog change type

Help function

When [Help] is touched in the menu bar, the help screen is displayed and guidance concerning the active test being executed is shown.

To close the help screen, touch [OK] at the top right of the screen.

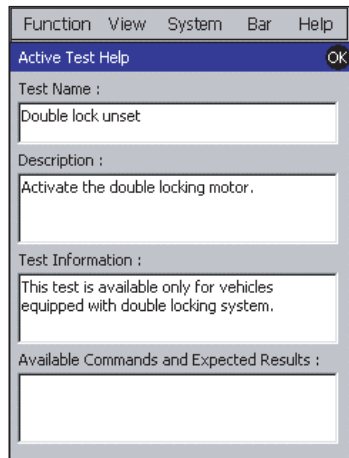

T00166E

Help screen

Utilities

The Intelligent Tester II has a utility with various functions.
The procedure for starting the utility is as follows.

1. From the main menu buttons, touch **Utility** .
Alternatively, touch [Utility] in the [Function] menu list.
The utility function select screen is displayed.
2. Touch the function to be executed on the utility function select screen.

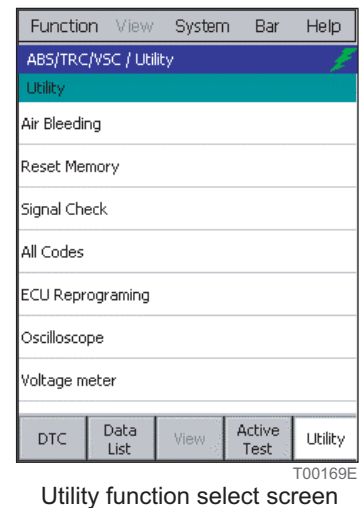
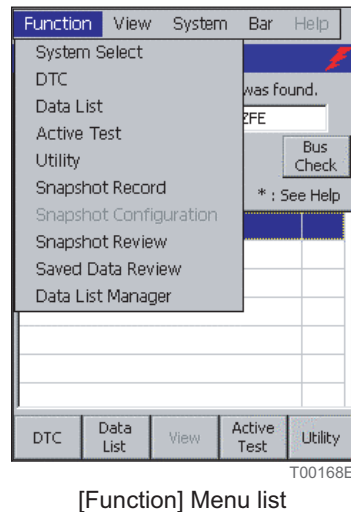
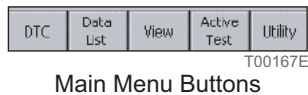

Explanation of Button Operations

This section explains button operations using the utility function ABS air bleeding as an example.

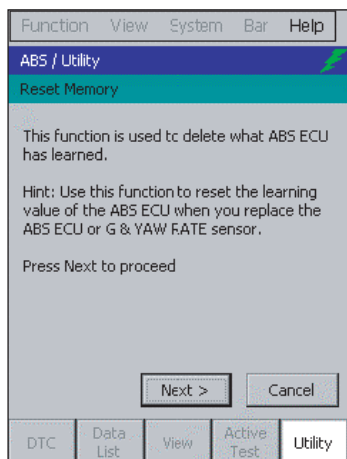

T00170E

Initial screen

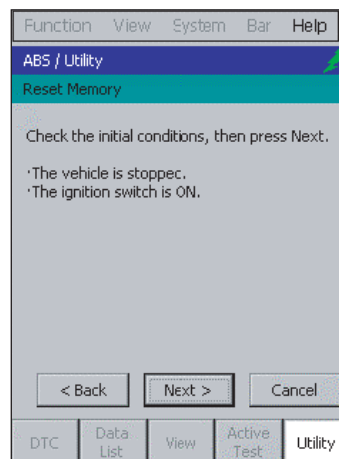

T00171E

Next screen

◆ ACTIVE KEY

- | | |
|--------|---|
| Next > | Moves the display to the next screen. |
| < Back | Returns the display to the previous screen. |
| Cancel | Cancel the utility function. |

NOTE

- Each screen displays notes and the procedure for proceeding with the operation. Proceed with the operation according to the procedures noted in the service manual and the contents displayed on the screen.

Explanation of ECU Reprogramming Functions

The ECU REPROGRAMMING application allows authorized service professionals to update ECU software without removing the ECU. Please note that there are many security checks performed by the ECU during the reprogramming process, so the specified reprogramming procedure must be followed carefully. *DO NOT attempt ECU reprogramming without proper training from the Toyota service division.*

The utility ECU Reprogramming utility functions are four functions for rewriting the ECU program.

- **Download Calibration File**
Downloads programming data from a PC.
- **Current Vehicle Calibration ID**
Acquires the vehicle ECU program ID.
- **Reprogramming**
Updates the ECU program.
- **Calibration File Manager**
Deletes the programming data stored in the Intelligent Tester II.

Select the function for execution from the ECU Reprogramming screen.

"Item Information" displays an explanation of the selected function.

The ECU to be reprogrammed can be selected from the system list box.

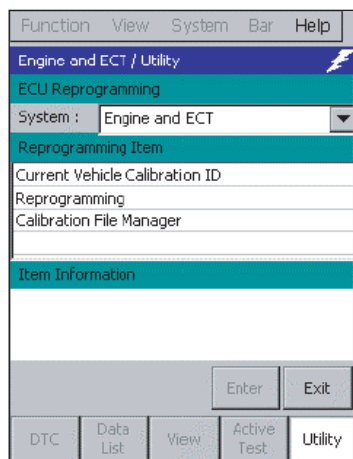

ECU Reprogramming screen

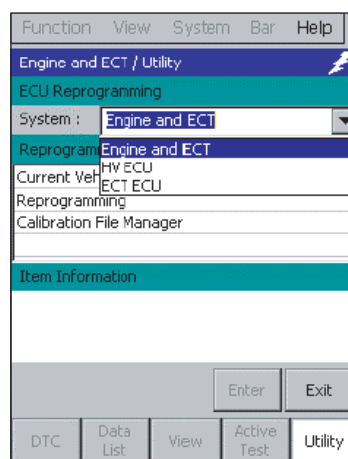

With the list box pulled down

◆ ACTIVE KEY

Enter

The selected function is executed. This is not valid unless the function has been selected.

Exit

Ends ECU Reprogramming.

Calibration File Manager

The programming data delete

1. Touch **Calibration File Manager** in the ECU Reprogramming screen.

Then, **Enter** button becomes effective.

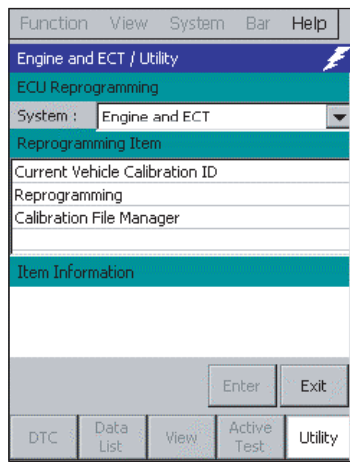

T00174E

ECU Reprogramming screen

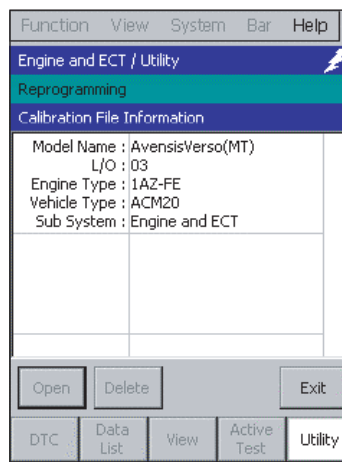

T00175E

Calibration file information screen

2. Touch **Enter** in the ECU Reprogramming screen.

The Calibration file information screen is displayed.

3. Touch the programming data. Then, the programming data becomes covered blue and **Delete** button becomes effective.

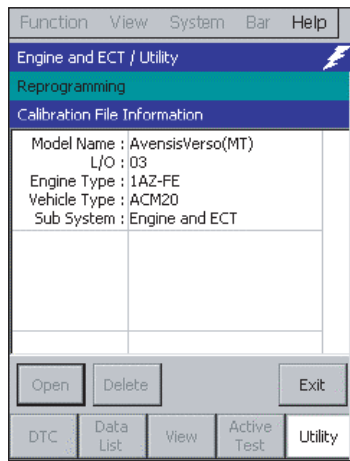

T00176E

Programming data selected

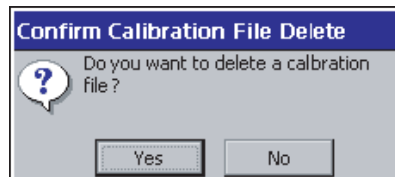

T00177E

Delete verification dialogue

4. Touch **Delete** in the Calibration file information screen.

The Delete verification dialogue is displayed.

5. Touch **Yes** in the Delete verification dialogue.

The programming data deletes.

◆ ACTIVE KEY

Delete Deletes the selected data.

Open Displays the calibration ID of the selected data.

Help function

When [Help] is touched in the menu bar, the help screen is displayed and guidance concerning the utility functions is shown.

To close the help screen, touch [OK] at the top right of the screen.

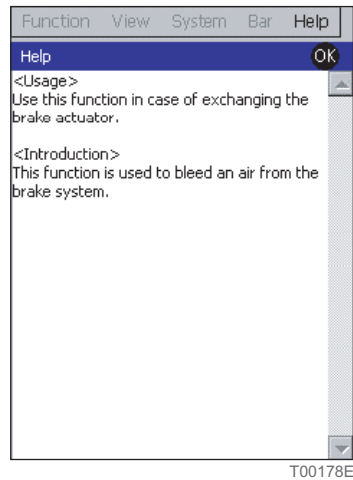

Help screen

5 Saved Data Playback Functions

5 Saved Data Playback Functions

The Intelligent Tester II not only has functions for diagnosing breakdowns in real time, but also has functions that can play back saved data afterwards.

The saved data playback functions do not require the Intelligent Tester II and the vehicle to connect.

The onboard/offboard check screen is displayed after the opening screen when the Intelligent Tester II is started up.

The saved data playback functions are the DTC playback and snapshot playback functions, and they can be started from the [Function] menu.

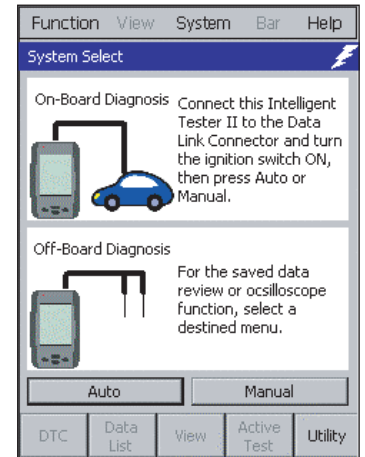

T00179E

Onboard/Offboard check screen

DTC Playback

Plays back saved DTC data.

The procedure for playing back DTC data is as follows.

1. From the [Function] menu list, touch [Saved Data Review].

The playback data select screen is displayed and a list of saved DTC data files is displayed.

2. On the playback data select screen, select the DTC data for playback and then touch  .

When DTC data is selected, file information is displayed in the File Information column. Touching  plays back the selected DTC data.

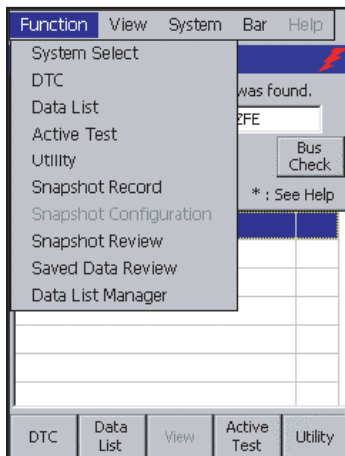

T00090E

[Function]Menu list

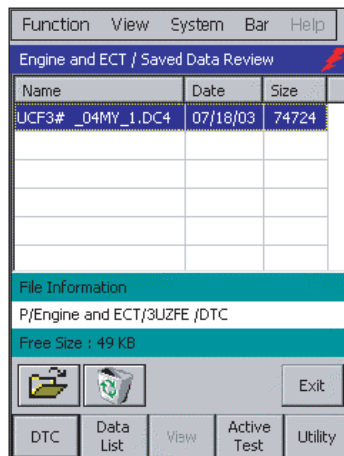

T00181E

Playback data select screen

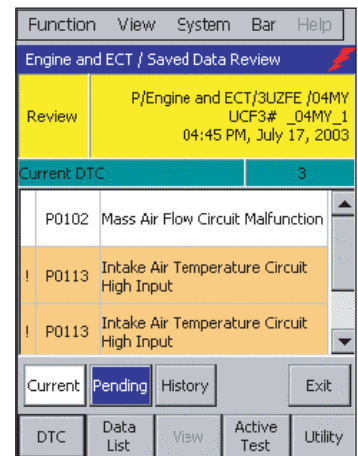

T00182E

DTC data playback screen

◆ ACTIVE KEY

Opens the selected DTC data and plays it back.



Deletes the selected DTC data.

Current

Displays saved the current DTC data.
When there is DTC data, this button is displayed in blue.

Pending

Displays saved pending DTC data.
When there is pending DTC data, this button is displayed in blue.

History

Displays saved historical DTC data (past codes).
When there is historical DTC data, this button is displayed in blue.

Exit

Ends playback data selection. (Playback data select screen)
Returns the display to the playback data select screen. (When saved DTC data is played back.)

Snapshot Playback

Plays back stored snapshot data.

The procedure for playing back snapshot data is as follows.

1. From the [Function] menu list, touch [Snapshot Review].

The playback data select screen is displayed and a list of saved snapshot data files is displayed.

2. On the playback data select screen, select the snapshot data for playback and then touch the  function button.

The selected snapshot is played back.

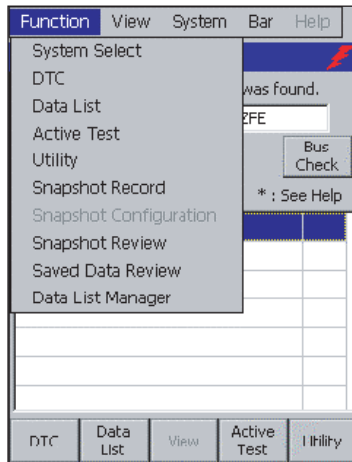

[Function] menu list

T00183E

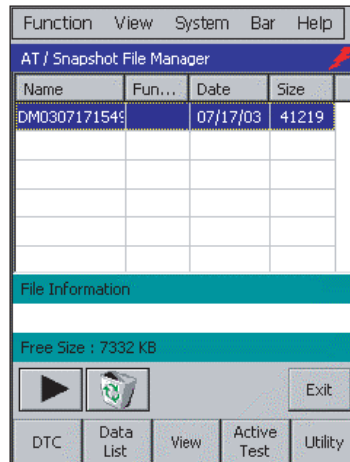

Playback data select screen

T00184E

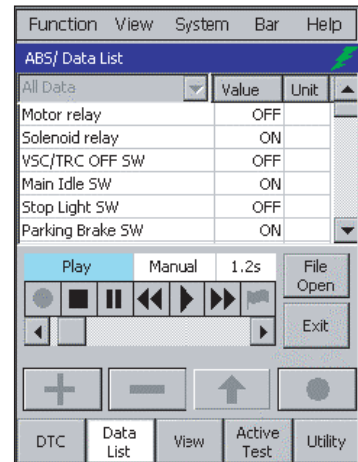

Snapshot data playback screen

T00185E

NOTE

- "DL" and "AT" may be displayed in the playback data selection screen Function column. "DL" means that the snapshot is from the data list, and "AT" means that it was saved while an active test was executed.

◆ ACTIVE KEY



Displays the playback screen and plays back the data.



Deletes the selected data.

File Open

Displays the playback data select screen.

Exit

Ends playback data selection. (Playback data select screen)
Returns the display to the playback data select screen. (During snapshot data playback.)



Stops playback and returns to the start of the data.



Pauses playback.



Fast forwards the data playback.



Starts the data playback.



Fast rewinds the data playback.



Moves to a point at which the snapshot flag is set and plays back from there.







T00186E

The playback position can be changed by touching or by moving the scroll bar to the left and right.

This bar is only valid during data list playback.

Playback With Snapshot Flag Set

When a snapshot flag is set, you can quickly move to the set point during snapshot playback. There are two methods for playback when a snapshot flag has been set.

- During normal playback, when a point is reached for which a snapshot flag is set, "  " is displayed in red. When the set point is passed, the "  " returns to its original color and playback continues.
- "  " is touched during playback, the snapshot flag point is displayed. When this point is selected, the "  " is displayed in red and snapshot data for the selected point is played back.

The above "  " is displayed in red for about 1 second, and the buzzer sounds at this time.

The playback screen when a snapshot flag is set is as follows.

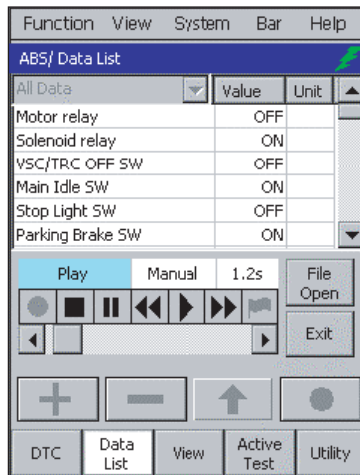



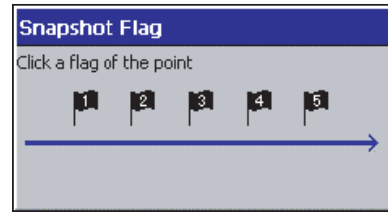





Screen for selecting point where snapshot flag is set.





Snapshot flag set point playback screen

◆ ACTIVE KEY

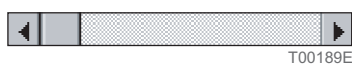
- | | |
|---|---|
|  | Displays the playback data select screen. |
|  | Returns the display to the playback data select screen. |
|  | Stops playback and returns to the start of the data. |
|  | Pauses playback. |
|  | Fast forwards the data playback. |
|  | Starts the data playback. |
|  | Rewinds the data playback. |
|  | Displays the dialog box for selecting the point where a snapshot flag is set. |



The playback position can be changed by touching   or by moving the scroll bar to be the left and right.
This bar is only valid during data list playback.

6 Measurement Functions

6 Measurement Functions

Voltage Measurement Functions

A voltage meter probe can be connected to the Intelligent Tester II for voltage measurement.

Measurement Function Selection Menu

1. From the main menu buttons of the system select screen, touch **Utility** .
The function select screen is displayed.

2. On the function select screen, touch **Voltage meter** .
The voltage display screen is shown and the voltage currently being measured is displayed in real time.

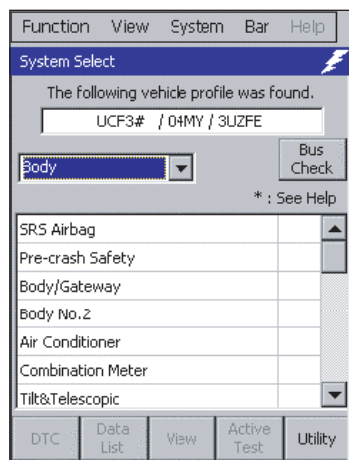

System select screen

T00190E

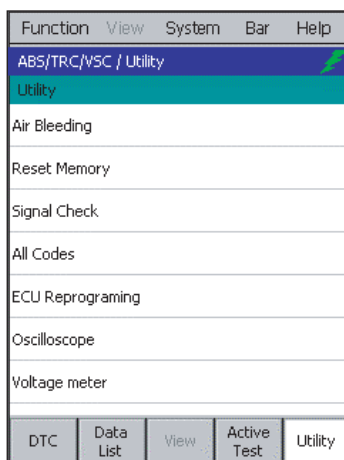

Function select screen

T00191E

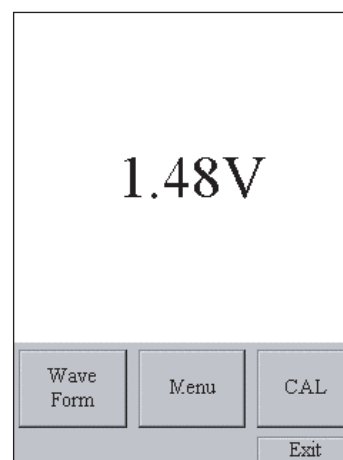

Voltage display screen

T00192E

Voltage Display

The voltage display screen is displayed.

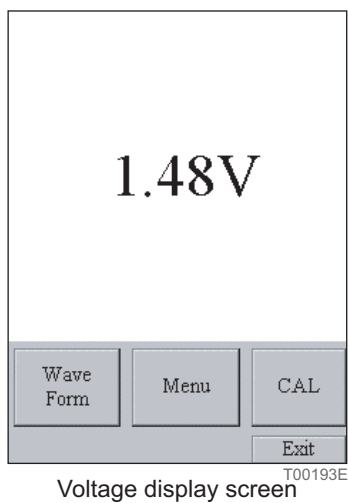

◆ ACTIVE KEY

Wave Form

Displays the waveform display screen. [Reference: Page 91](#)

Menu

Saves/plays back/deletes screen images. [Reference: Page 94](#)

CAL

Executes calibration. [Reference: Page 93](#)

EXIT

Ends voltage measurement.

Waveform Display

The waveform display screen is displayed.

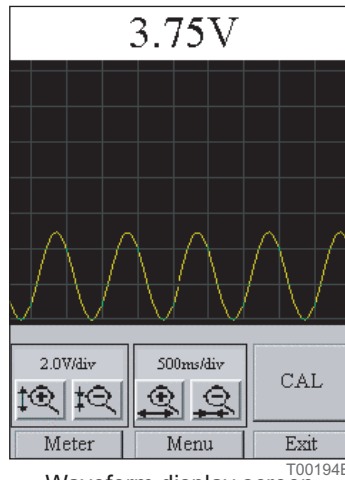

Waveform display screen

The following operations can be executed on the waveform display screen.

- The voltage (vertical axis) and time (horizontal axis) range settings can be changed.
- Waveform updating can be stopped and resumed.
Pressing the right function key on the main unit stops waveform updating; pressing it again resumes updating.

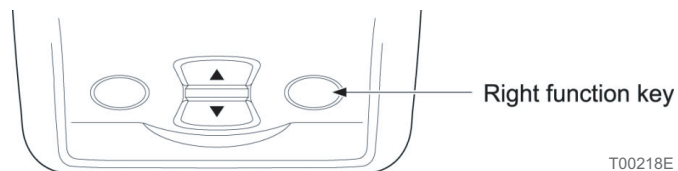

◆ **ACTIVE KEY**



Voltage axis
enlargement

The waveform is enlarged vertically each time the button is touched.
The current voltage range is displayed at the top of the button.



Voltage axis
reduction

The waveform is reduced vertically each time the button is touched.
The current voltage range is displayed at the top of the button.



Time axis
enlargement

The waveform is enlarged horizontally each time the button is touched.
The current time range is displayed at the top of the button.



Time axis
reduction

The waveform is reduced horizontally each time the button is touched.
The current time range is displayed at the top of the button.

CAL

Executes calibration. [Reference: Page 93](#)

Meter

Returns the display to the voltage display screen.

Menu

Saves/plays back/deletes screen images. [Reference: Page 94](#)

Exit

Ends voltage measuremen.

Calibration

Calibrates the zero point.

1. Touch **CAL** on the voltage display screen or the waveform display screen.
The calibrating dialog box is displayed.

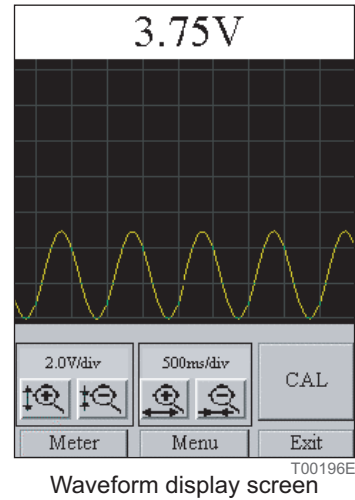
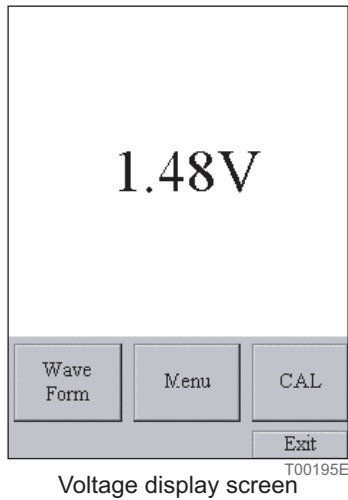

2. Connect the voltage measurement tester probe to the reference point.
3. On the calibrating dialog box, touch **OK**.
The calibrating dialog is displayed. When the calibration is complete, the hint dialog box is displayed.
Do not remove the probe during calibration.

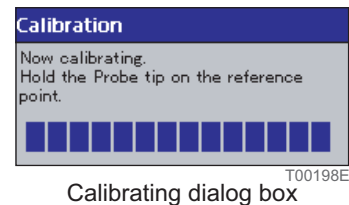
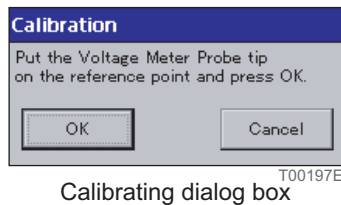

4. Check the contents of the hint dialog, then touch **OK**.
When calibration ends, the tip dialog box is displayed automatically.
This dialog displays an explanation for stopping/resuming waveform updating using the right function key on the main unit.



Screen Image Save/Playback/Delete

Saves/plays back/deletes screen images.

Screen image save

1. Touch **Menu** on the voltage display screen or the waveform display screen.
The file menu screen is displayed.
2. Touch **Save Screen Copy** on the file menu screen.
The screen image save screen is displayed.

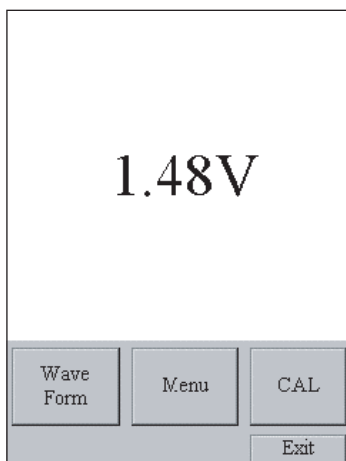

Voltage display screen T00200E

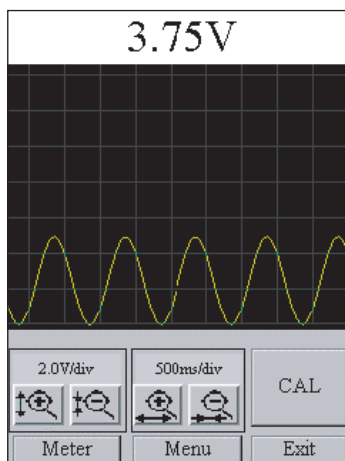

Waveform display screen T00201E

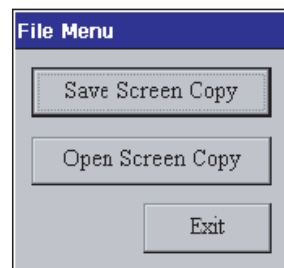

File menu screen T00202E

3. The set file name is displayed on the screen image save screen.

If this file name is correct, touch **Save** .

To a different file, input the name of that file and then touch **Save** .

A comment to be attached to the saved data can be input in the comment column.

Reference: Page 30 Software keyboard operation (Chapter 2. Basic Operations/Basic Operations/Display Operation)

"File creation date and time_serial number" is set automatically as the file name displayed.

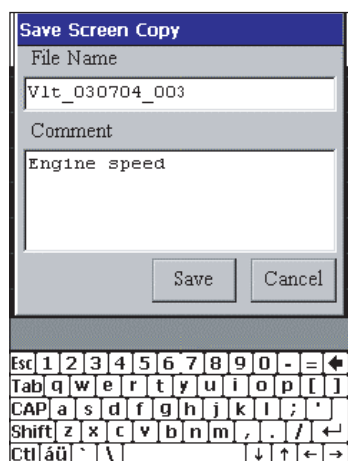

Screen image save screen T00203E

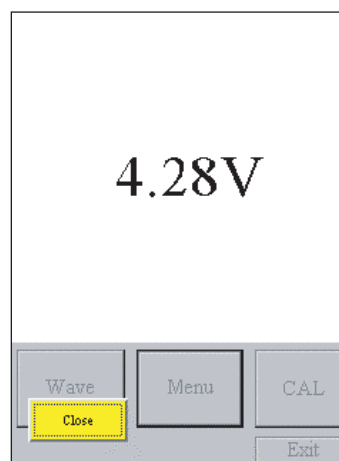

Screen image playback screen T00204E

◆ ACTIVE KEY

SAVE Screen Copy	Executes screen image save processing.
OPEN Screen Copy	Executes screen image playback/delete processing.
Exit	Returns the display to the previous screen.
Save	Saves a screen image.
Cancel	Returns the display to the file menu screen.

Screen Image Playback/Delete

■ Playing back a screen image

1. Touch **Menu** on the voltage display screen or the waveform display screen.
The file menu screen is displayed.
2. Touch **Open Screen Copy** on the file menu screen.
The screen image select screen is displayed.

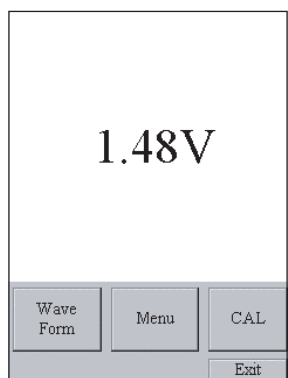

T00205E
Voltage display screen

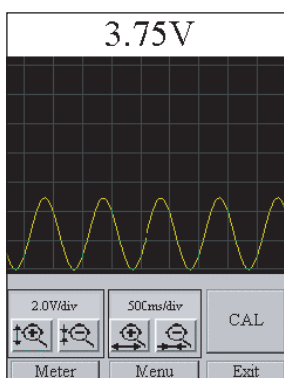

T00206E
Waveform display screen

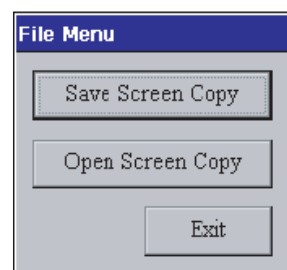

T00207E
File menu screen

3. After touching the playback screen image on the screen image select screen, touch **Open**.
The playback screen for the selected screen image is displayed.

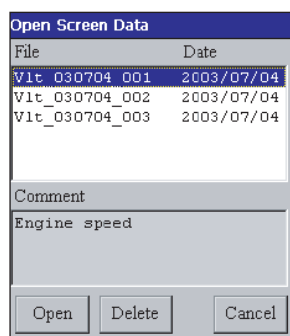

T00208E
Screen image select screen

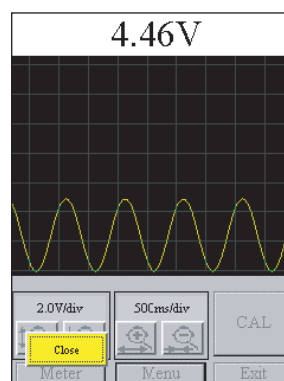

T00209E
Screen image playback screen

◆ ACTIVE KEY

Save Screen Copy	Executes screen image save processing.
Open Screen Copy	Executes screen image playback/delete processing.
Exit	Returns the display to the previous screen.
Open	Plays back the selected screen image.
Delete	Deletes the selected screen image.
Cancel	Returns the display to the file menu screen.

■ Deleting a screen image

1. Touch **Menu** on the voltage display screen or the waveform display screen.
The file menu screen is displayed.
2. Touch **Open Screen Copy** on the file menu screen.
The screen image select screen is displayed.

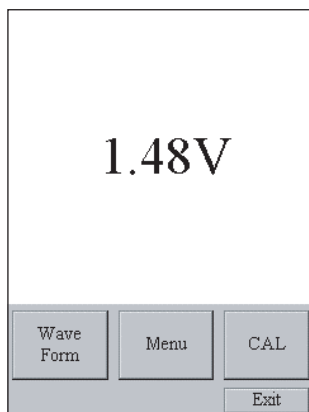

Voltage display screen

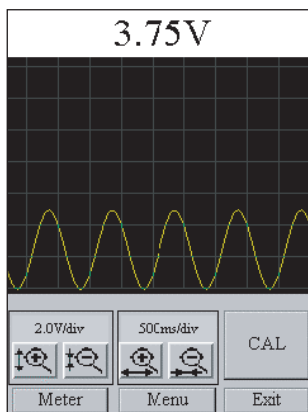

Waveform display screen

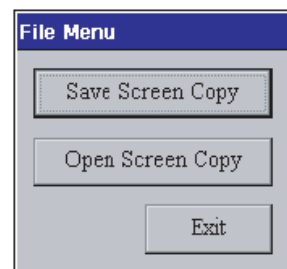

File menu screen

3. After touching the screen image for deletion on the screen image select screen, touch **Delete** .
The selected screen image is deleted.

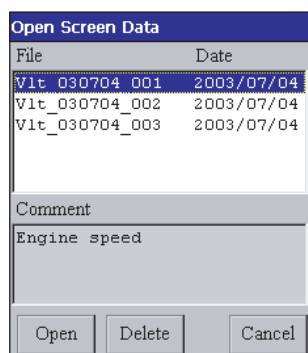

Screen image select screen

◆ ACTIVE KEY

Save Screen Copy	Executes screen image save processing.
Open Screen Copy	Executes screen image playback/delete processing.
EXIT	Returns the display to the previous screen.
OPEN	Plays back the selected screen image.
Delete	Deletes the selected screen image.
Cancel	Returns the display to the file menu screen.

Oscilloscope Functions

To use the oscilloscope function, it is necessary to connect the optional oscilloscope cartridge.

The oscilloscope probes can be connected to the Intelligent Tester II to observe the voltage waveform for the signals input to the channels.

Do not connect the AC/DC adapter to the Intelligent Tester II, when using the oscilloscope function.

Oscilloscope Measurement Menu

- From the main menu buttons of the system select screen, touch **Utility** .
The function select screen is displayed.
- On the function select screen, touch **Oscilloscope** .
The oscilloscope measurement screen is displayed.

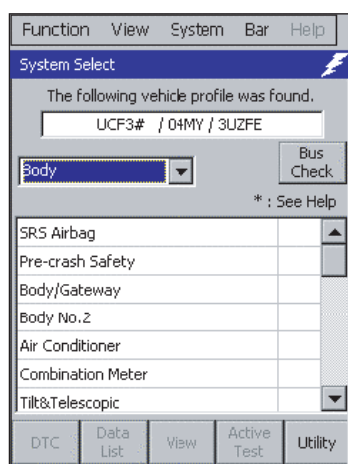

System select screen

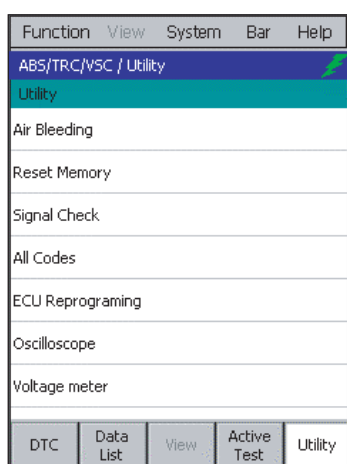

Function select screen



Oscilloscope measurement menu screen

◆ ACTIVE KEY

- | | |
|---------|--|
| Menu | Saves/plays back/deletes screen images and measurement condition setting data.
<i>Reference: Page 105</i> |
| EXIT | Ends the oscilloscope function. |
| Trigger | Displays the trigger menu screen. <i>Reference: Page 101</i> |

Waveform Display

The following operations can be executed on the waveform display screen.

- The voltage (vertical axis) and time (horizontal axis) range settings can be changed.
- The ground level (0V position) can be set for the selected channel.

NOTE

- The voltage (vertical axis) range and ground level (0V position) are set for the selected channel.

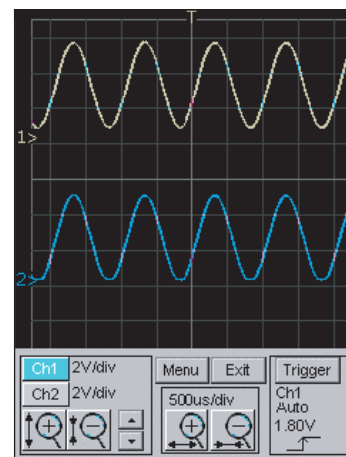

Waveform display screen

- Waveform updating can be stopped and resumed.
Pressing the right function key on the main unit stops waveform updating;
pressing it again resumes updating.

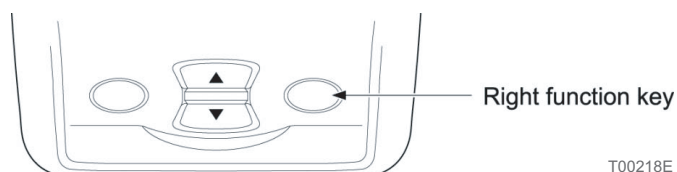

◆ **ACTIVE KEY**

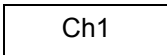
 Ch1 The channel for the voltage (vertical axis) range and ground level (0V position) is set to "Ch1". When this is selected, the button is displayed in blue.

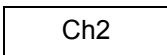
 Ch2 The channel for the voltage (vertical axis) range and ground level (0V position) is set to "Ch2". When this is selected, the button is displayed in blue.

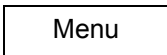
 Menu Saves/plays back/deletes screen images and measurement condition setting data.
Reference: Page 105

 Exit Ends the oscilloscope function.

 Trigger Displays the trigger menu screen. *Reference: Page 101*

 Vertically enlarges the waveform for the selected channel.
The current voltage range is displayed to the right of the selected channel.
Voltage axis enlargement

 Vertically reduces the waveform for the selected channel.
The current voltage range is displayed to the right of the selected channel.
Voltage axis reduction

 The waveform is enlarged horizontally each time the button is touched.
The current voltage time range is displayed at the top of the button.
Time axis enlargement

 The waveform is reduced horizontally each time the button is touched.
The current voltage time range is displayed at the top of the button.
Time axis reduction

 ▲ Raises the ground level (0V position) for the selected channel.

 ▼ Lowers the ground level (0V position) for the selected channel.

Trigger Menu

Detailed settings can be performed for a parameter trigger.

- Trigger channel setting
- Trigger mode setting
- Trigger level setting
- Trigger slope switching
- Trigger point setting

1. On the oscilloscope measurement menu screen, touch **Trigger**.

The trigger menu screen is displayed.

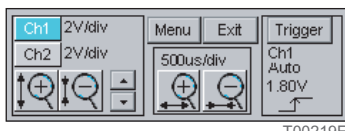

Oscilloscope measurement menu screen

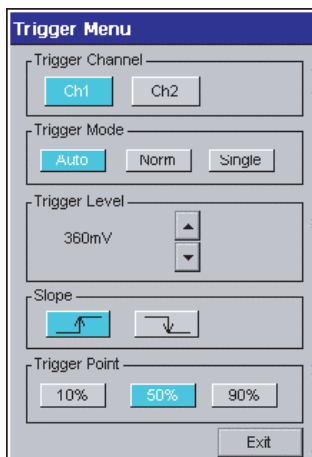

Trigger menu screen

◆ ACTIVE KEY

Exit Exits the trigger menu and displays the message dialog.

■ Message dialog box

When the trigger menu is exited, the message dialog box on the right is displayed automatically.

This dialog box displays an explanation of stopping/resuming waveform updating using the right function key on the main unit.

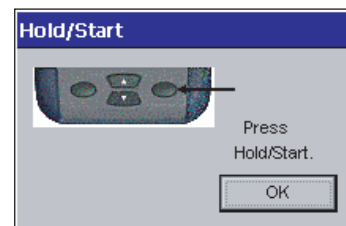

T00221E

Trigger channel setting

Switches the trigger channel.
The selected button is displayed in blue.

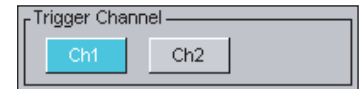

T00222E

◆ ACTIVE KEY

Sets the trigger channel to "Ch1".

Sets the trigger channel to "Ch2".

Trigger mode setting

Sets the trigger mode.
The selected button is displayed in blue.
The meanings of the trigger modes are as follows.



T00223E

● Auto

The waveform is displayed regardless of the trigger specification.

● Norm

The waveform is only displayed when the specified trigger is detected. (The waveform is updated when the next trigger is detected.)

● Single

The waveform from when the specified trigger is first detected is held (the display is fixed).

◆ ACTIVE KEY

Sets the trigger mode to [Auto].

Sets the trigger mode to [Norm].

Sets the trigger mode to [Single].

Trigger level setting

Sets the trigger level.
The set trigger level is displayed to the left side of the button.

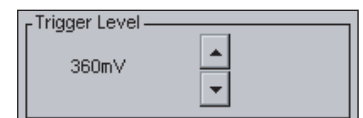

T00224E

◆ ACTIVE KEY

Raises the trigger level.

Lowers the trigger level.

Trigger slope switching

Switches the trigger slope.
The selected button is displayed in blue.



T00225E

◆ ACTIVE KEY

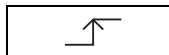

Sets the trigger to the rising edge.

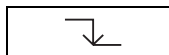

Sets the trigger to the falling edge.

Trigger point setting

Sets the trigger point.
The selected button is displayed in blue.

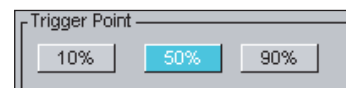

T00226E

◆ ACTIVE KEY

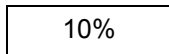

Sets the trigger point to 10%.

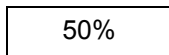

Sets the trigger point to 50%.

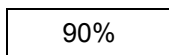

Sets the trigger point to 90%.

■ Trigger points

This section uses the following two examples to explain trigger points.

- To observe the waveform from the set trigger point onward, select a trigger point of 10%.

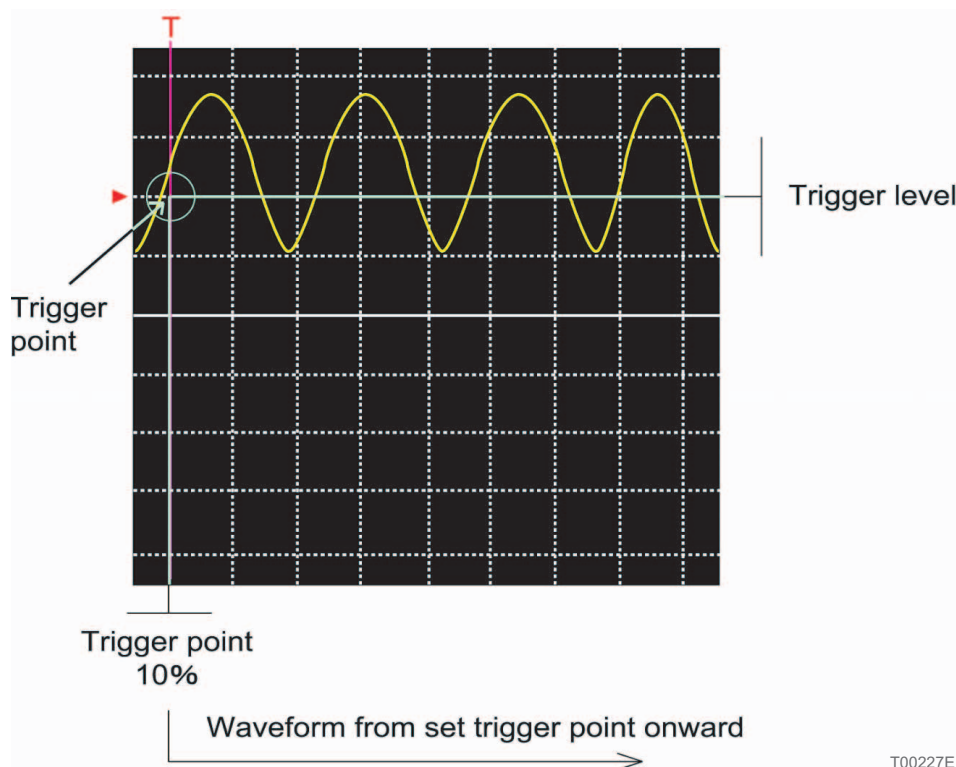

T00227E

- To observe the waveform up to the set trigger point, select a trigger point of 90%.

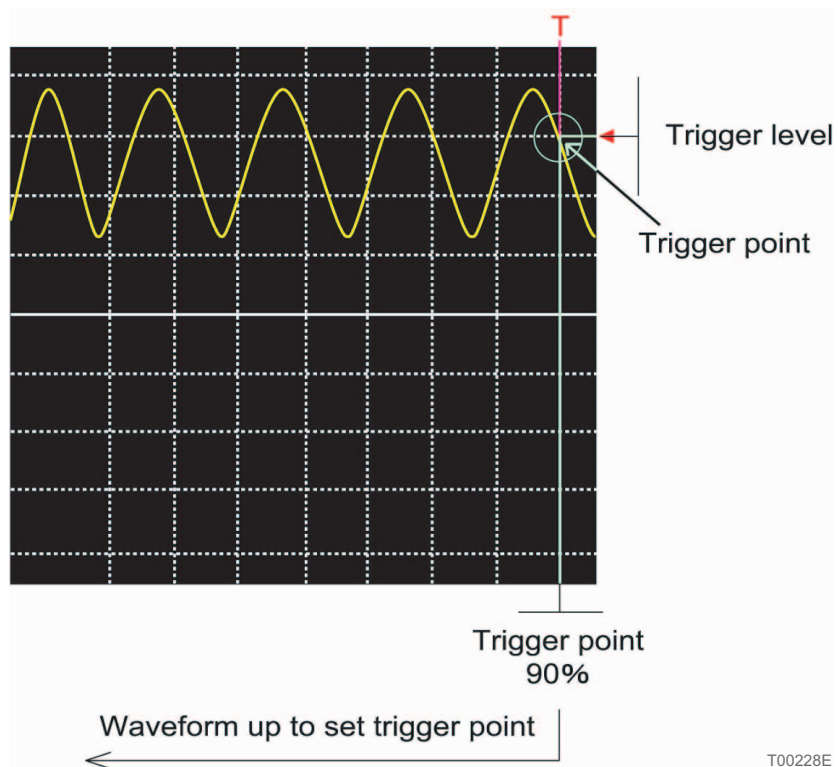

T00228E

Screen Image Save/Playback/Delete

Saves/plays back/deletes screen images and measurement condition setting data.

Screen image save

1. On the oscilloscope measurement menu screen, touch **Menu** .
The file menu screen is displayed.
2. Touch **Save Screen Copy** on the file menu screen.
The screen image save screen is displayed.



Oscilloscope measurement menu screen

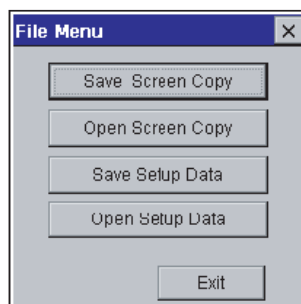

File menu screen

3. The set file name is displayed on the screen image save screen.
If this file name is correct, touch **Save** .
To save to a different file, input the name of that file and then touch **Save** .

A comment to be attached to the saved data can be input in the comment column.

Reference: Page 30 Software keyboard operation (Chapter 2. Basic Operations/Basic Operations/Display Operation)

"File creation date and time_serial number" is set automatically as the file name displayed.

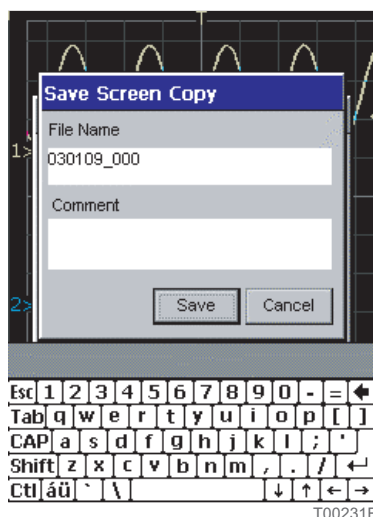

Screen image save screen

◆ ACTIVE KEY

Save Screen Copy	Executes screen image save processing.
Open Screen Copy	Executes screen image playback/delete processing.
Save Setup Data	Executes save processing of the measurement condition setting data.
Open Setup Data	Executes the measurement condition setting data playback/deleteprocessing.
Exit	Returns the display to the oscilloscope measurement menu.
Save	Saves a screen image.
Cancel	Returns the display to the file menu screen.

Screen Image Playback/Delete**■ Playing back a screen image**

1. On the oscilloscope measurement menu screen, touch **Menu** .

The file menu screen is displayed.

2. Touch **Open Screen Copy** on the file menu screen.

The screen image select screen is displayed.



T00232E

Oscilloscope measurement menu screen

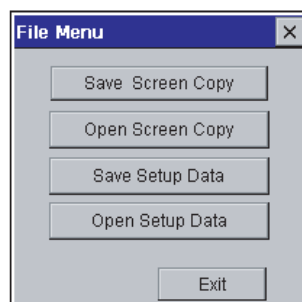

T00233E

File menu screen

3. After touching the playback screen image on the screen image select screen, touch **Open** .

The playback screen for the selected screen image is displayed.

"File creation date and time_serial number" is set automatically as the file name displayed.

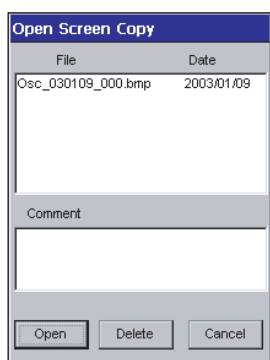

T00234E

Screen image select screen

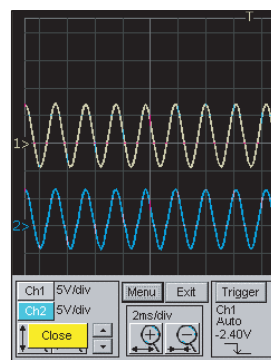

T00235E

Screen image playback screen

◆ ACTIVE KEY

- | | |
|--------|--|
| Open | Plays back the selected screen image. |
| Delete | Deletes the selected screen image. |
| Cancel | Returns the display to the file menu screen. |

Deleting a screen image

1. On the oscilloscope measurement menu screen, touch **Menu** .
The file menu screen is displayed.
2. Touch **Open Screen Copy** on the file menu screen.
The screen image select screen is displayed.



Oscilloscope measurement menu screen

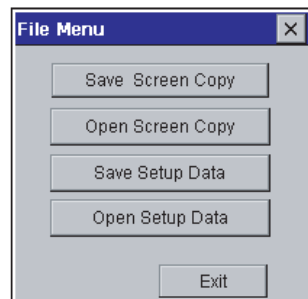

File menu screen

3. After touching the screen image for deletion on the screen image select screen, touch **Delete** .
The selected screen image is deleted.

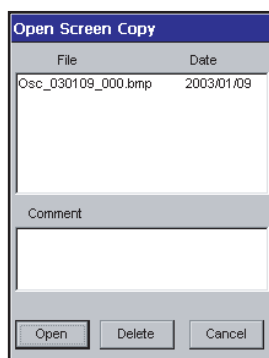

Screen image select screen

ACTIVE KEY

- | | |
|--------|--|
| Open | Plays back the selected screen image. |
| Delete | Deletes the selected screen image. |
| Cancel | Returns the display to the file menu screen. |

Saves the measurement condition setting data

1. On the oscilloscope measurement menu screen, touch **Menu** .
The file menu screen is displayed.
2. Touch **Save Setup Data** on the file menu screen.
The measurement condition setting data save screen is displayed.

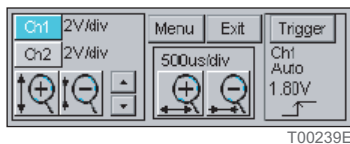
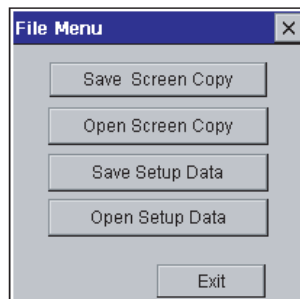
T00239E
Oscilloscope measurement menu screenT00240E
File menu screen

3. The set file name is displayed on the measurement condition setting data save screen. If this file name is correct, touch **Save** .
To save to a different file, input the name of that file, and then touch **Save** .

A comment to be attached to the saved data can be input in the comment column.

Reference: Page 30 Software keyboard operation (Chapter 2. Basic Operations/Basic Operations/Display Operation)

"File creation date and time_serial number" is set automatically as the file name displayed.

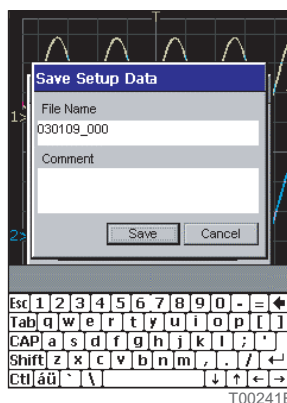
T00241E
Measurement condition setting data save screen**◆ACTIVE KEY**

Save Saves the measurement condition setting data.

Cancel Returns the display to the file menu screen.

Plays back/deletes measurement condition setting data.**■ Playing back measurement condition setting data**

1. On the oscilloscope measurement menu screen, touch **Menu** .

The file menu screen is displayed

2. Touch **Open Setup Data** on the file menu screen.

The measurement condition setting data select screen is displayed.

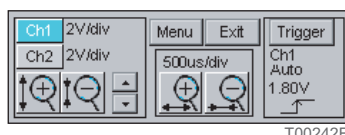

Oscilloscope measurement menu screen

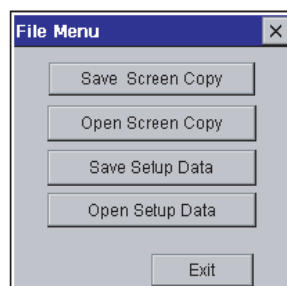

File menu screen

3. After touching the playback screen image on the measurement condition setting data select screen, touch **Open** .

The playback screen for the measurement condition setting data is displayed.

"File creation date and time_serial number" is set automatically as the file name displayed.



Measurement condition setting data select screen

◆ ACTIVE KEY

- | | |
|--------|---|
| Open | Plays back the selected measurement condition setting data. |
| Delete | Deletes the selected measurement condition setting data. |
| Cancel | Returns the display to the file menu screen. |

■ Deleting measurement condition setting data

1. On the oscilloscope measurement menu screen, touch **Menu** .
The file menu screen is displayed.
2. Touch **Open Setup Data** on the file menu screen.
The measurement condition setting data select screen is displayed.

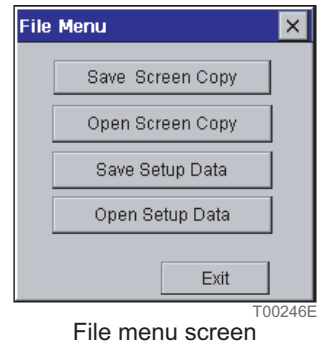
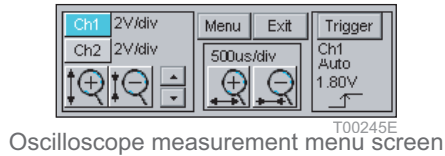

3. After touching the screen image for deletion on the measurement condition setting data select screen, touch **Delete** .
The selected measurement condition setting data is deleted.

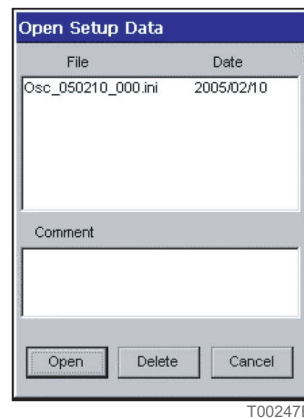
**◆ ACTIVE KEY**

- | | |
|--------|---|
| Open | Plays back the selected measurement condition setting data. |
| Delete | Deletes the selected measurement condition setting data. |
| Cancel | Returns the display to the file menu screen. |

7 Handling

7 Handling

Handling Precautions

Pay attention to the following points when handling the Intelligent Tester II and its accessories.

- Do not leave this tester or any of its accessories exposed to direct sunlight for long periods of time.
- In locations with high humidity, the display back light can deteriorate and the brightness decrease. Use and store in locations with low humidity.
- Also, in low-temperature locations, the display response may be slow.
This phenomenon is normal and is caused by the characteristics of the LCD display.
- When cleaning the tester or accessories, never use paint thinner or any other solvent or volatile oil product. This could cause deformation, discoloration, and other such problems as well as loss of function. Wipe gently with a soft cloth dipped in a diluted neutral detergent.
- After updating diagnosis software, all setting parameters that were changed using the tool option function will be reset to their default settings (factory settings).
Go back and manually change settings, as needed.
- When the Intelligent Tester II is left unused for a prolonged time, the clock may become inaccurate or stop altogether. If this happens, reset the clock.
- If the internal battery is allowed to remain completely drained for a long time, this will drastically reduce its service life. Even when not using the Intelligent Tester II, charge the internal battery at least once a month.

Disposal

When disposing of the Intelligent Tester II or any of its accessories, please do the following.

- The Intelligent Tester II and its accessories contain electronic parts installed using solder that includes lead. In order to prevent damage to the environment resulting from this lead, ask the waste processing company to handle this equipment separate to ordinary non-burnable material.
- The plastic case of the Intelligent Tester II is made of polycarbonate, ABS, and acrylic. Excluding the clear panel (acrylic), the plastic parts have materials abbreviations stamped inside. In order to recycle these compound plastic products, ask the waste processing company to handle the different plastics separately.
- The main unit of the Intelligent Tester II and the oscilloscope cartridge have a lithium ion internal battery. Dispose of used internal batteries in accordance with the regulations of the nation and region.

Battery Replacement

This product uses a lithium ion battery. When replacing the battery, read the cautions below carefully and replace the battery correctly and safely.

WARNING

● Always observe the following rules. Failure to do so can result in heat generation, fire, blowout, or battery fluid leakage.

- Do not use any battery other than the lithium ion battery supplied by DENSO (95171-10341).
- Do not heat or burn the battery.
- Do not disassemble or alter this battery.
- Do not short the terminals.
- Do not use, charge, or leave the battery in any high-temperature location.



CAUTION

● Correctly dispose of used-up batteries in accordance with legal requirements.

Items to prepare

- Philips screwdriver (The standard depends on the region.)
- Replacement battery (DENSO 95171-10341) 1

Replacement procedure

1. Loosen the five screws on the rear of the main unit with a Philips screwdriver and take out the cartridge.

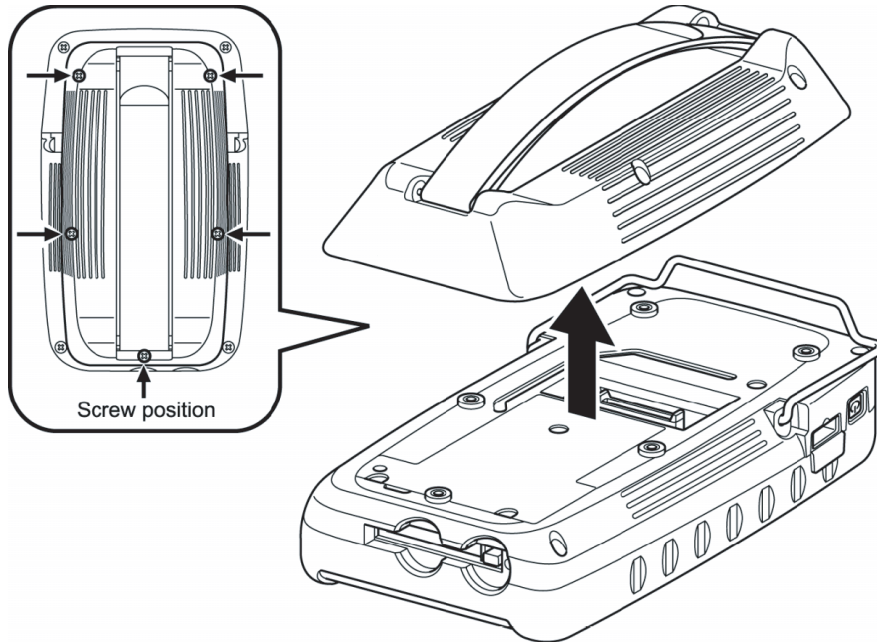

T00248E

2. Loosen the screw securing the lid of the battery case with a Philips screwdriver and take off the lid.

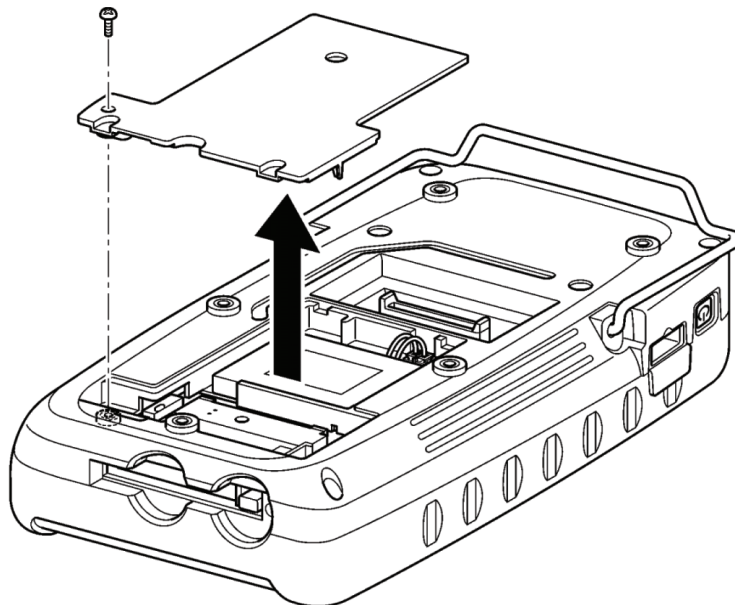

T00249E

3. Pull out the battery from the battery case.

When removing the battery from the battery case, if you disconnect the leads from the connector, protect the tips of the leads with insulating tape to avoid a short.

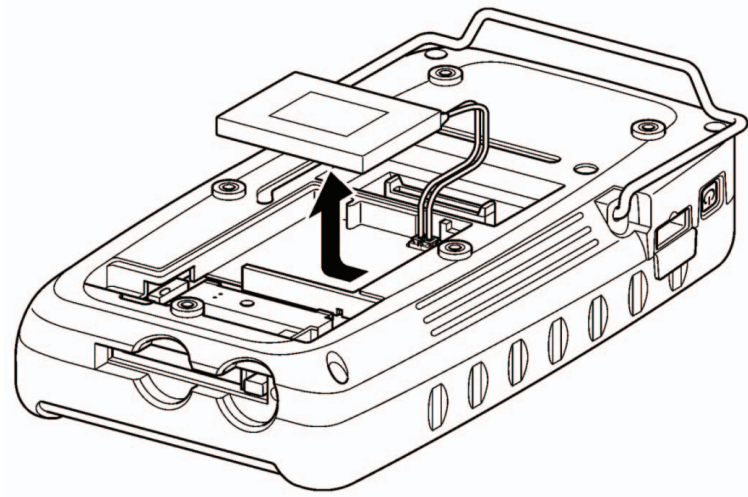

T00250E

4. Remove the connector.

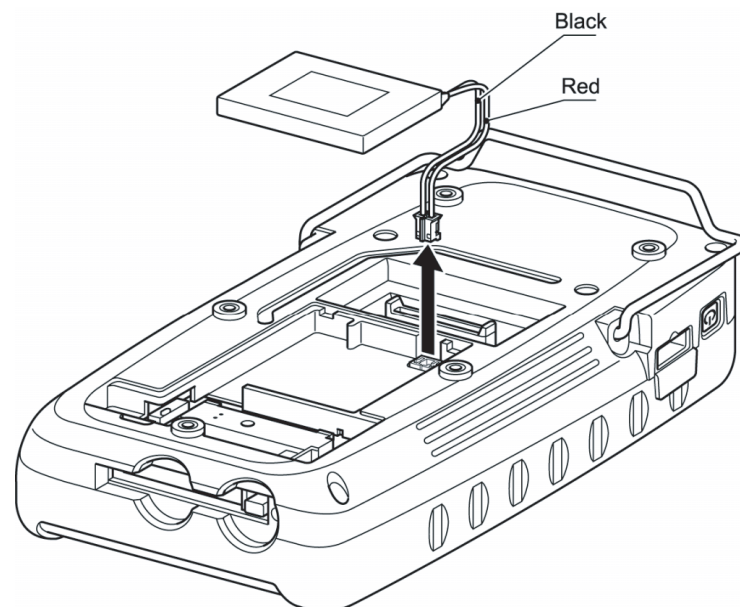

T00251E

5. Replace the battery with a new one and install the connector. Always connect as in the figure below, so that the red lead is on the right.

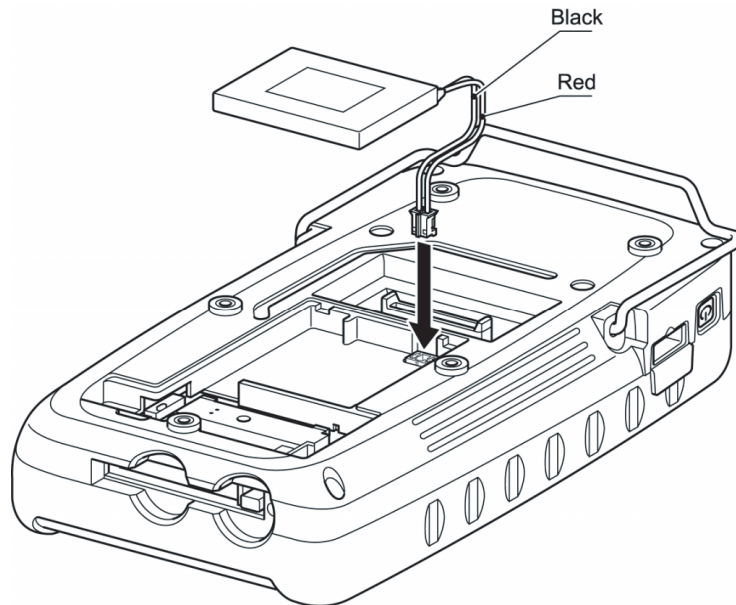

T00252E

6. Insert the battery all the way into the case so that it fits completely inside the case.

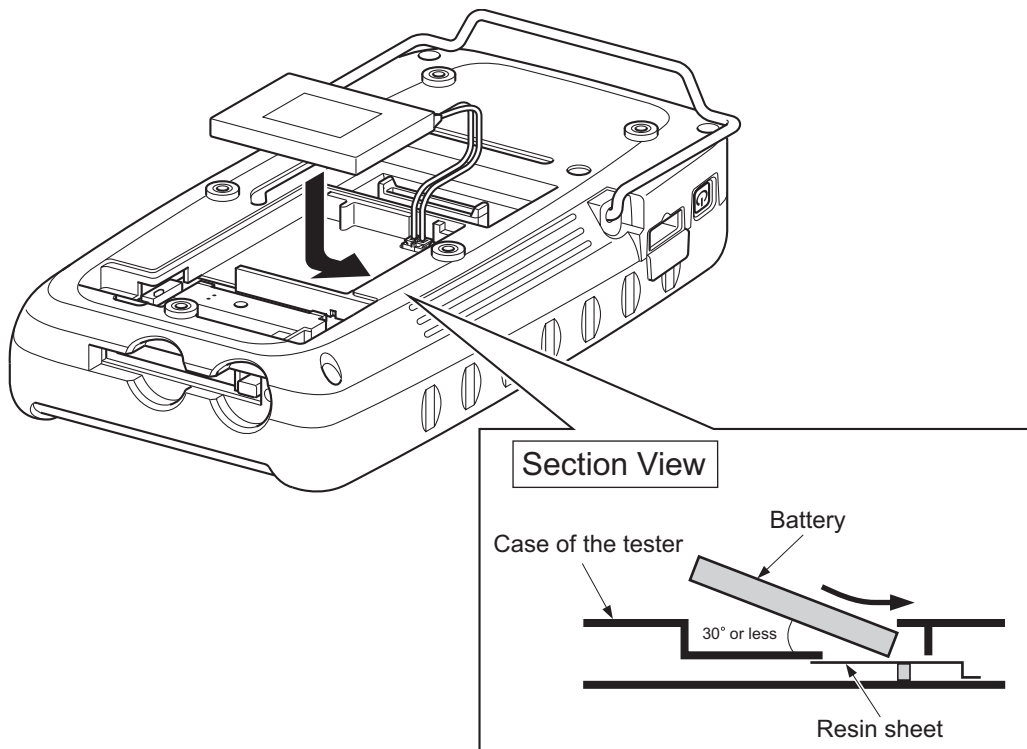

T01024E

⚠ CAUTION

- Keep the angle to insert the battery at 30° or less, and insert as sliding it on the resin sheet.
- Do not apply too much pressure on the resin sheet.

7. Close the lid of the battery case and tighten the screw to a torque of 0.3 ± 0.1 Nm with a Philips screwdriver.

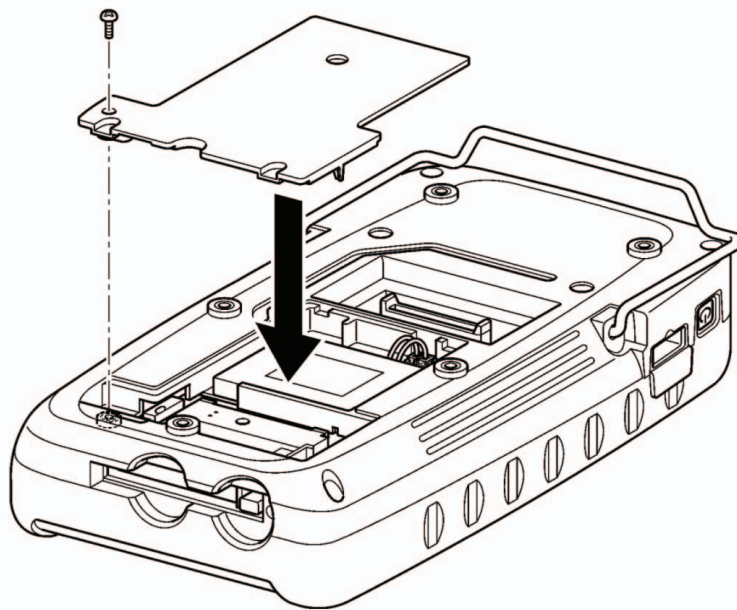

T00254E

8. Mount the cartridge in the main unit and tighten the five screws to a torque of 0.5 ± 0.1 Nm with a Philips screwdriver.

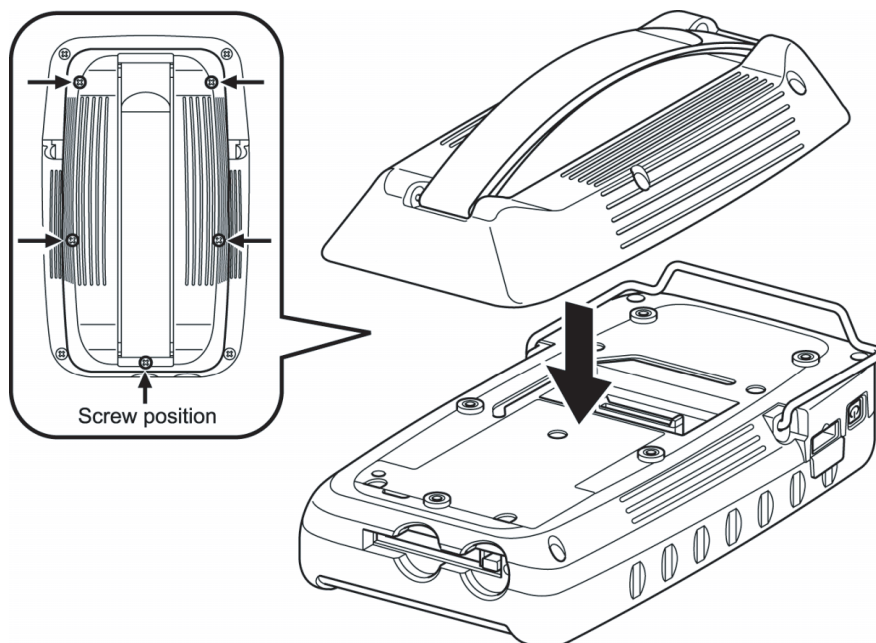

T00255E

8 Product Specifications

8 Product Specifications

Intelligent Tester II Specifications

Item	Specifications	
Main unit dimensions	145mm (W) x 223mm (H) x 71mm (D)	
Main unit weight	Without oscilloscope cartridge: about 1200g With oscilloscope cartridge: about 1380g	
Main unit power supply voltage	DC10 - 32V	
Power consumption	Without oscilloscope cartridge: Normally 5.5W (12VDC), charging 8.5W (12VDC) With oscilloscope cartridge: Normally 7W (12VDC), charging 10W (12VDC)	
Usage temperature	0 - 45°C	
Storage temperature	-10 - 60°C	
OS	Windows CE (DENSO original HPC type), English OS	
CPU	Hitachi SH7727 128 MHz	
RAM	32MB	
ROM	Flash: 32 MB	
Liquid crystal	5.7-inch color (320x240) transparent type 256 colors <ul style="list-style-type: none"> • Brightness can be adjusted. • Contrast can be adjusted. (Only for manufacturing model "DN-IT2-001") 	
Touch panel	Input: Finger Surface strength: Pencil lead hardness 2Hmin. Operating force: 80g max.	
Keys	Four (up, down, and two function keys)	
Internal clock	Time stamp (backed up by internal battery)	
PC communications	PC card slot	CF x 1ch (supports CF standard Type I and Type II)
	USB	Host: 1 channel Function: 1 channel
	Serial	1ch (RS-232C)
Vehicle communications	CAN	1ch (Fast CAN)
	ISO9141	1 channel (standard 12V specifications)
Backup power supply	Lithium ion battery 7.4V 1000mAh	
Charge time (at normal temperature)	5 hours (time until full charge)	
Battery usage time (at normal temperature)	For normal operation: about 1 hour (with expansion : about 80 minutes)	
Regulation	CE	

Voltage Measurement Function Specifications

Item	Specifications
Maximum sampling rate	250s / sec
Number of channels	1ch
Voltage (vertical axis) range	1V / div, 2V / div, 5V / div
Time (horizontal axis) range	100ms / div, 200ms / div - 10s / div

Oscilloscope Function Specifications

Item	Specifications
Maximum sampling rate	500ks / sec
Number of channels	2ch
Sweep mode	Auto, Normal, Single
Voltage (vertical axis) range	100mV / div, 200mV / div, 500mV / div - 10V / div
Time (horizontal axis) range	50 μ s / div, 100 μ s / div, 200 μ s / div - 10s / div (200 ms and higher is roll mode)
Trigger position	10%, 50%, and 90% of display surface
Battery usage time (at normal temperature)	0.8 hours

9 After-Service

I. WARRANTY

- 1.Intelligent Tester II ("Products") is warranted to be free from defects in material and workmanship (Screen Overlay is excluded from this warranty).
- 2.The warranty period for the Products is from the date of shipment to you until the date when one year has passed thereafter.
- 3.This warranty does not cover any part that has been abused, altered, used for a purpose other than that which it was intended, or used in a manner inconsistent with instructions regarding its use, including, but not limited to, the following:
 - Damage due to improper operation or modification of the Product;
 - Damage due to use of the cables and accessory items not originally supplied, or unauthorized peripheral equipment;
 - Damage due to dropping or other severe impact on the Products;
 - Damage due to reverse polarity of 12-volt power and ground;
 - Damage due to exposure to excessive temperatures; or
 - Damage or loss that may occur during shipping.

This warranty excludes failure, breakdown, damage or loss of the Products caused or induced by any faults or defects of software of the Products.

This warranty also excludes all incidental or consequential damage.

II. REPAIR SERVICE

- 1.If there is a problem with the Products, please read the "Operator's Manual" carefully to make sure that the Product is being operated properly.
- 2.If this does not resolve the problem, please fill in the required information on the "Repair Order Sheet"* , including a brief explanation of the problem, the name of the failed Products, and your return address, and send it to a DENSO Overseas Subsidiary (or TOYOTSU AUTO SERVICE Japan, if purchased through TOYOTSU AUTO SERVICE Japan) by Fax.
Please fill in the "Repair Order Sheet" in English.
*The "Repair Order sheet" is in the Operator's Manual.
- 3.The DENSO Overseas Subsidiary (or TOYOTSU AUTO SERVICE Japan) will send a reply.
Please follow the instructions in the reply. If the DENSO Overseas Subsidiary (or TOYOTSU AUTO SERVICE Japan) requests the failed parts to be sent back, please send the failed parts with the "Repair Order Sheet"* attached on a freight collect basis.
- 4.If the problem is determined to be within the scope of warranty as defined in Paragraph I (one) above, it will be repaired or replaced with no charge and the return freight prepaid.
If the problem is determined to be out of the scope of warranty, the DENSO Overseas Subsidiary (or TOYOTSU AUTO SERVICE Japan) will inspect the failed Products and reply with a quotation for the repair cost.
After the DENSO Overseas subsidiary (or TOYOTSU AUTO SERVICE Japan) receives your request for repair, the item will be repaired for a nominal service charge plus freight cost.

If you have any questions regarding the procedures for warranty and repair service, please contact a DENSO Overseas Subsidiary (or TOYOTSU AUTO SERVICE Japan).

TOYOTSU AUTO SERVICE Japan & DENSO Overseas Subsidiary Company name/Address	Tel/Fax
TOYOTSU AUTO SERVICE CO.,LTD Export & Import Department Address: 248-2 Shimoshiota Narumi-cho, Midori-ku, Nagoya, Aichi 458-0801, JAPAN	Tel: +81-52-621-3277 Fax: +81-52-621-3288
DENSO INTERNATIONAL AUSTRALIA PTY LTD Sales and Marketing Dept. Address: 255 Melrose Drive, Tullamarine Victoria 3043 Australia	Tel: +61-3-9279-2900 +61-3-9279-2979 Fax: +61-3-9279-2902
DENSO INTERNATIONAL SINGAPORE PTE. LTD. Sales and Service Address: 51 Science Park Road #01-19/26 The Aries, Singapore 117586	Tel: +65-6776-8268 Fax: +65-6776-8698
P.T.DENSO SALES INDONESIA Marketing Dept. Address: JL. Gaya Motor I, Sunter II Kel Sungai, Bambu, Tanjung Priok, Jakarta Utara, Jakarta Indonesia	Tel: +62-21-651-2279 Fax: +62-21-651-2284
DENSO (MALAYSIA) SDN.BHD. Address: Ground Floor No.14 Jalan Glenmarie Section Selangor, Malaysia	Tel: +60-3-5569-9933 Fax: +60-3-5567-3300
PHILIPPINES AUTO COMPONENTS INC. Service and After Market Sales Dept. Address: Road 1 Lot 1, Phase II-A, Carmelray Industrial Park, Canlubang, Calamba Laguna, The Philippines	Tel: +63-49-549-3030 Fax: +63-49-549-3088
DENSO TAIWAN CORP Sales Dept Address: 桃園縣楊梅鎮瑞唐里梅獅路二段525 号	Tel: +886-3-482-8001 Fax: +886-3-482-8003
DENSO INTERNATIONAL (THAILAND) CO., LTD Aftermarket Sales Address: 369 Moo 3 Teparak Road, Teparak A. Muang, Samutprakarn 10270 Thailand	Tel: 66-2-384-2871 66-2-384-4646 Fax: 66-2-384-0884 66-2-384-3747
DENSO EUROPE B.V for Sales: Aftermarket, Sales Section 1 for Service: Aftermarket, Service Section 6 Address: Hogeweyselaan 165, 1380 JL Weesp The Netherlands	Tel: 31-294-493-493 31-294-493-657 Fax: 31-294-417-122
DENSO (CHINA) INVESTMENT CO.,LTD Address: Room No.518 The Beijing Fortune Building, No.5 Dong SanHuan Bei-Lu, Chao Yang District, Beijing, 100004 China	Tel: +86-10-6590-8025 Fax: +86-10-6590-8021
DENSO SALES INDIA PVT. LTD. Address: The Capital Court, 3rd Floor, Left Wing, Olof Palme Marg, Munirka, New Delhi-110 067, India	Tel: +91-981-001-5960 Fax: +91-11-2618-2474

Regulatory Information to user

MODEL : DN-IT2-001 and DN-IT2-002

1. FCC Regulations

This device complies with part 15 of the FCC Rules. Operation is subject to the following two conditions :

- (1) This device may not cause harmful interference, and
- (2) this device must accept any interference received, including interference that may cause undesired operation.

FCC WARNING : Changes or modifications not expressly approved by the party responsible for compliance could void the user's authority to operate the equipment.

NOTE: This equipment has been tested and found to comply with the limits for a Class B digital device, pursuant to part 15 of the FCC Rules. These limits are designed to provide reasonable protection against harmful interference in a residential installation. This equipment generates, uses and can radiate radio frequency energy and, if not installed and used in accordance with the instructions, may cause harmful interference to radio communications. However, there is no guarantee that interference will not occur in a particular installation. If this equipment does cause harmful interference to radio or television reception, which can be determined by turning the equipment off and on, the user is encouraged to try to correct the interference by one or more of the following measures:

- Reorient or relocate the receiving antenna.
- Increase the separation between the equipment and receiver.
- Connect the equipment into an outlet on a circuit different from that to which the receiver is connected.
- Consult the dealer or an experienced radio/TV technician for help.

2. ICES-003 Regulations

This Class B digital apparatus complies with Canadian ICES-003.

Cet appareil numérique de la classe B est conforme à la norme NMB-003 du Canada.

Manufacturer's Declaration of Conformity in accordance with EC EMC Directive 2004/108/EC

We herewith confirm that under product described below is met the requirements of EC EMC directive 2004/108/EC

Manufacturer

Name : DENSO CORPORATION
Address : 1-1 Showa-cho, Kariya-shi, Aichi-ken, 448-8661 Japan

Importer

Name : DENSO EUROPE B.V.
Victor Schipper
Address : Hogeweyselaan 165, 1382 JL Weesp,
The Netherlands

Description of Product

Product name : Intelligent Tester II
Product model Number : DN-IT2-001 and DN-IT2-002

Harmonized Standards applied : EN 55022
: EN 61000-6-2



Intelligent Tester II Repair Order Sheet

Please fill this sheet and send to your distributor with failure products when you request to repair Intelligent Tester II.

<Your Details>

Dealer name		Purchasing Date	/	/	
Contact Person's Name		Failure Date	/	/	
Address	Country _____ Postcode _____				
Phone No.		Shipping date	/	/	
Fax. No.		Warranty	<input type="checkbox"/> In	<input type="checkbox"/> Out	

<Description of Failure> Please tick the boxes below.

WHEN	<input type="checkbox"/> Always <input type="checkbox"/> Sometimes(more than 1/day)	<input type="checkbox"/> Rarely(less than 1 /day) <input type="checkbox"/> Other(_____)
WHAT	<input type="checkbox"/> Tester <input type="checkbox"/> Display <input type="checkbox"/> Touch Panel <input type="checkbox"/> A/C Adaptor <input type="checkbox"/> Communication(vehicle) <input type="checkbox"/> Communication(USB)	<input type="checkbox"/> Cable(Power) <input type="checkbox"/> Cable(Communication) <input type="checkbox"/> Oscilloscope <input type="checkbox"/> Voltage meter <input type="checkbox"/> Others { _____ }
HOW	<input type="checkbox"/> Error code displayed <input type="checkbox"/> No display shown <input type="checkbox"/> No response/operation <input type="checkbox"/> No communication <input type="checkbox"/> No charge	<input type="checkbox"/> No measurement <input type="checkbox"/> Command will freeze <input type="checkbox"/> No power <input type="checkbox"/> Others { _____ }
COMMENT		

<Product sent for repair> Please tick the boxes below and write Serial No.

<input type="checkbox"/> Tester [Software Version Ver. _____]	<input type="checkbox"/> RS232C Cable	
<input type="checkbox"/> Voltage Meter Probe	<input type="checkbox"/> USB Cable	<input type="checkbox"/> Others { _____ }
<input type="checkbox"/> AC/DC Power Supply	<input type="checkbox"/> Oscilloscope Probe	
<input type="checkbox"/> DLC3 Cable	<input type="checkbox"/> Cigarette lighter power cable	Serial No. _____

<Distributor Use Only>

Distributor Name			
Contact Person's Name			
Phone No.		Comment	
Fax No.			
Shipping Date			

<DENSO Use Only>

Body S/No. _____	Jacket S/No. _____	Repair date	/	/
------------------	--------------------	-------------	---	---