

BMW DIS Troubleshooting

Troubleshooting & Diagnostic Procedures

Subject	Page
Troubleshooting and Diagnostic Procedures	2
Diagnostic Communication	3
CAN Bus Topology	5
Control Module Variant Encoding and Programming	7
BMW Diagnosis	8
Programmable Control Modules: Siemens MS42.0	12
BMW Diagnosis Control Unit Functions.	13
Electronic Throttle Control EML - 12 Cylinder	14
BMW Diagnosis.	22

TROUBLESHOOTING & DIAGNOSTIC PROCEDURE

The specific EML control system you happen to be troubleshooting/diagnosing dictates what method of diagnostic procedure you must follow.

Before the DIS was available, the Diagnostic Manuals provided information for diagnostic procedure. There are Diagnostic Manuals for the E32/34 and E31 vehicles. These manuals are still an excellent source of information for pre DIS systems.

The Diagnostic Manuals provide:

- System Functional Descriptions
- Info on the control module's diagnostic system.
- Abbreviations pertaining to system
- Control Module Pin assignments
- Troubleshooting test procedures with nominal values
- Defect/Fault Code explanations
- Component testing information
- Technical Data

With the introduction of the DIS all of the Diagnostic Manual information was incorporated into the DIS software for E-38 and E-46. Data communication with a specific control module provides an up-to-date system specific interface. The DIS provides Fault Symptom troubleshooting procedures with access to Fault codes, Status Requests, Component Activation, Special Service functions, etc.

This section provides information regarding how the control modules communicate diagnostic information and/or fault recognition to the DIS and with each other via CAN communication.

Additionally, Control Module Variant Encoding or Control Module programming is another topic that must be considered when diagnosing a system. If a control module has been coded or programmed incorrectly, it could possibly induce driveability complaints and or incorrect system function.

Finally, this section provides examples of using the Diagnostic Manual "Paper" information method in conjunction with the DIS and a system using the "DIS" alone.

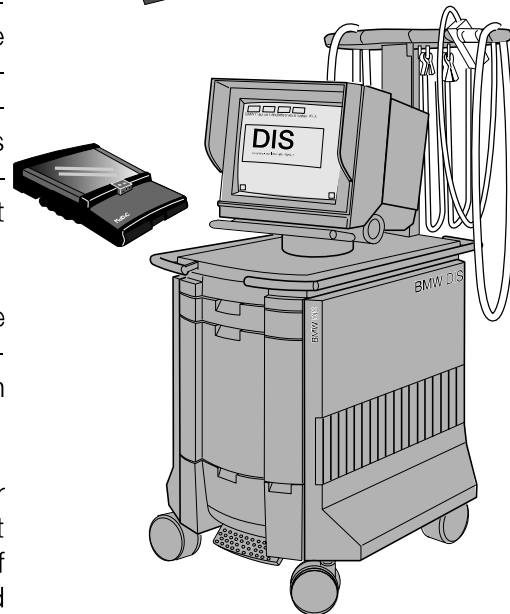
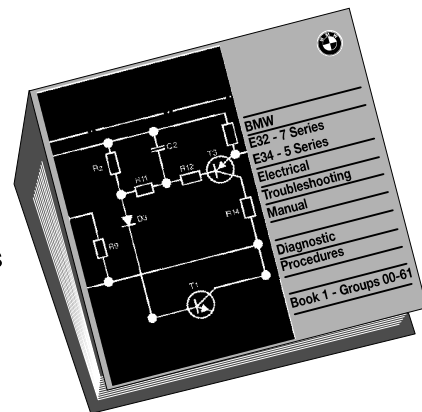

DIAGNOSTIC COMMUNICATION

DIS/MoDiC to control module communication is dependent on the integrity of the Diagnostic Link (D-Bus). The diagnostic link is a wire circuit in the vehicle that connects to all control modules designed to communicate with the DIS tester. The connection point for the DIS with the diagnostic link in the vehicle is at the 20 pin diagnostic connector in the engine compartment.

The diagnostic link has evolved through the model years as follows:

RXD/TXD: The wires in the 20 pin connector are identified as RXD (pin 15) and TXD (pin 20). This configuration is used with all M1.x and M3.x DME systems.

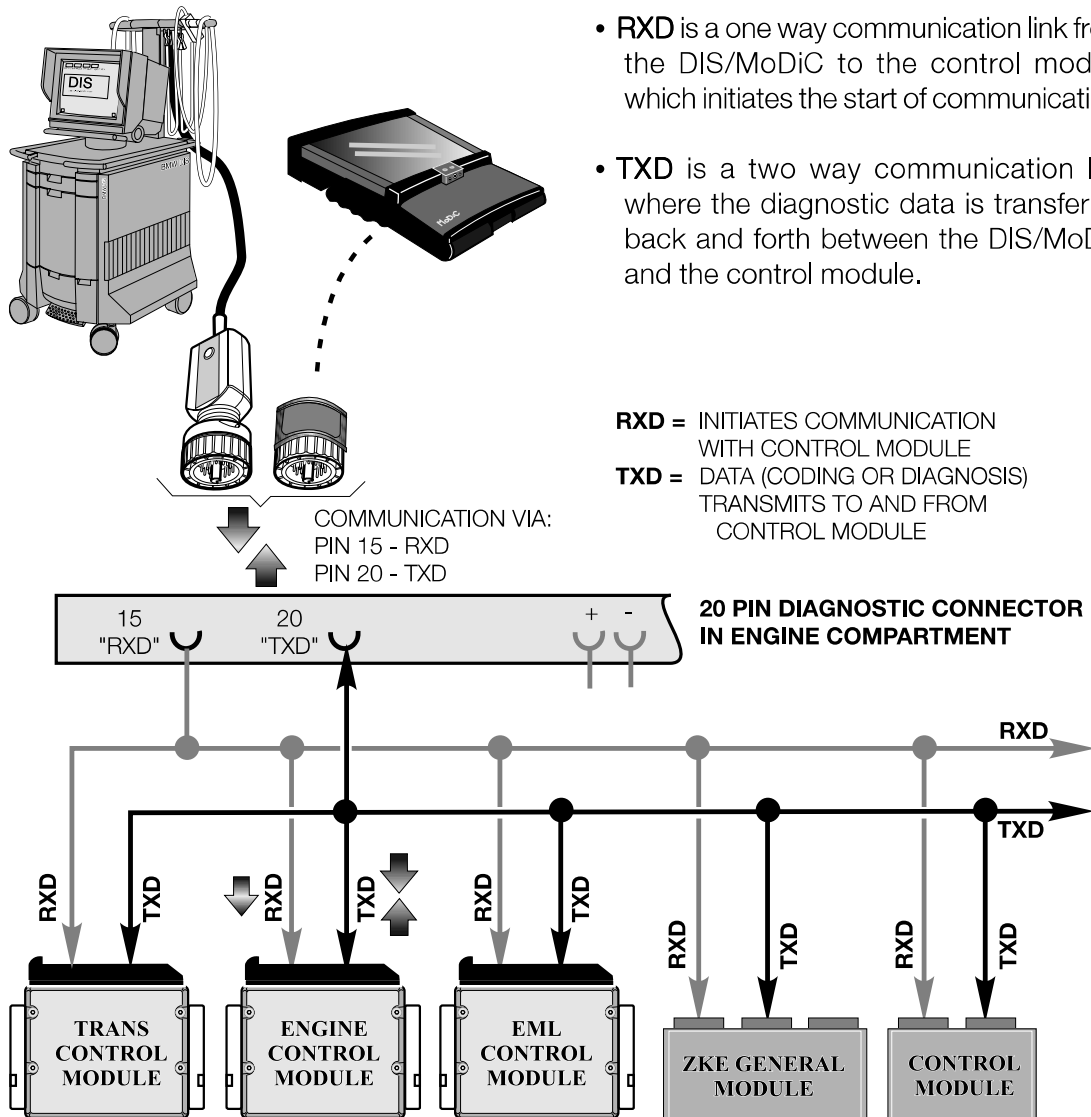

TXD II: With the introduction of OBD II, the diagnostic link changed to meet the needs of the OBD II Data Link Connector (DLC). The DLC is located in the passenger compartment and provides a connection for an aftermarket scantool for powertrain systems only. Scantool communication with these control modules is only possible when the 20 pin diagnostic connector cap is installed. A circuit bridge in the cap completes the DLC circuit.

The original RXD/TXD link is still in the vehicle for non powertrain systems. But, (control module dependent) RXD may not be used at all since later control modules communicate with the D2 protocol (different language) which only requires TXD (single wire communication).

TXD II (pin 17) was added to the 20 pin diagnostic connector to provide a separate connection to Drivetrain control modules (DME, AGS, EML) for OBD II compliance. The separate connection is for security reasons. The DIS/MoDiC share the same TXD II wire though the scantool and DIS/MoDiC communicate with different "languages".

- Scantool "speaks" ISO 9141 protocol.
- DIS/MoDiC "speak" D2 protocol.

If problems are encountered trying to establish communication, consider the following:

- Battery voltage too low (connect a battery charger prior to communication).
- Power and Ground circuits for the control module possibly open.
- Diagnostic link circuits possibly open or shorted.

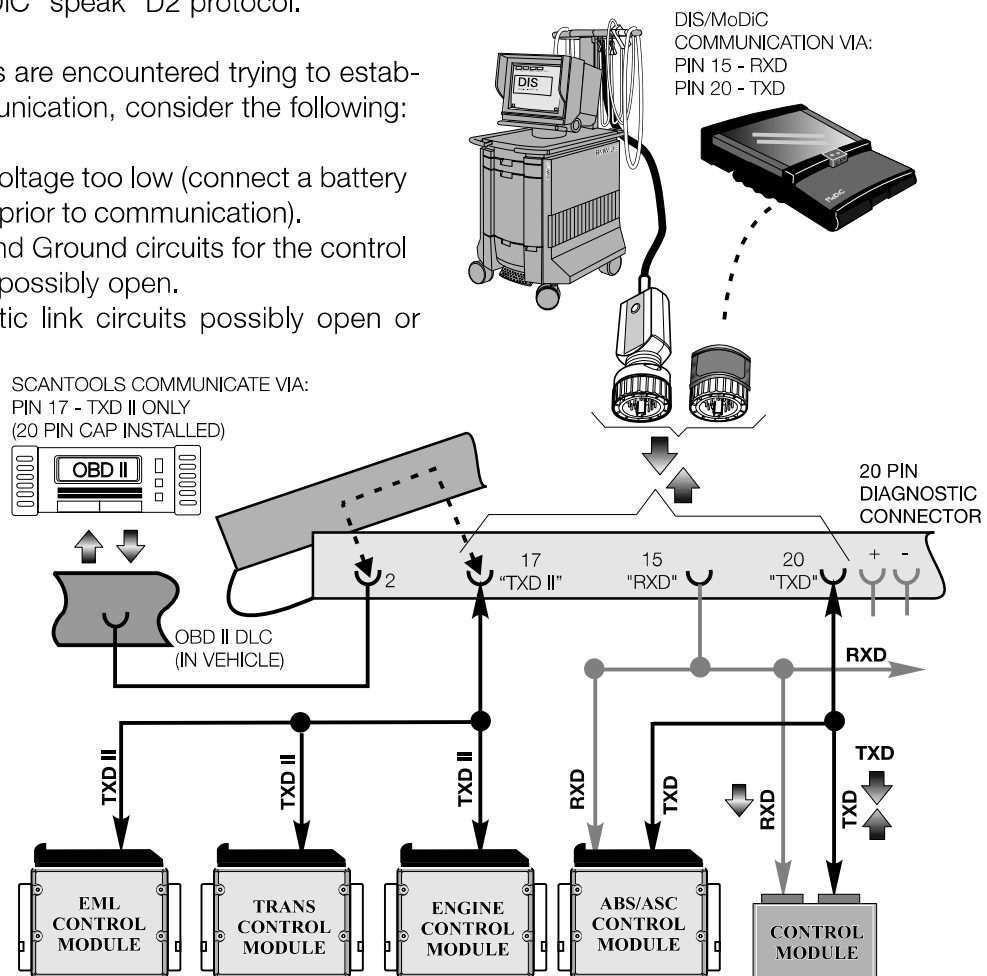

CAN BUS TOPOLOGY

Introduced with the 1993 740i/iL, the Controller Area Network (CAN) provides a fast communication link between the Engine and Transmission Control Modules serving as both an input and output multiple signal bus. The CAN consists of two wires (CAN High and CAN Low) with a ground shield. In its early configuration, the CAN bus is a simple end user bus system.

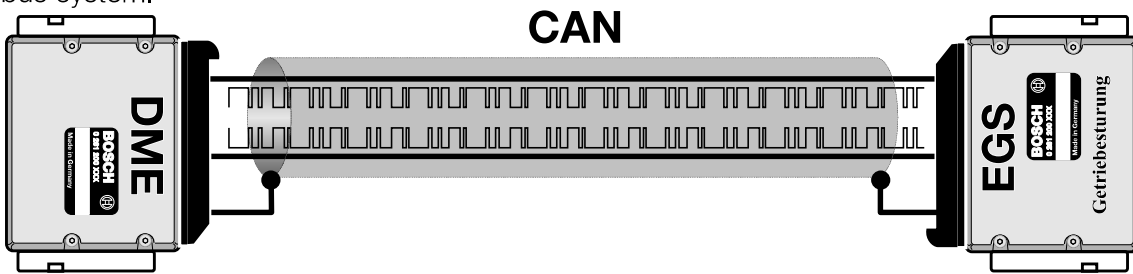

With the introduction of the 1995 750iL, the CAN bus was expanded to include both engine control modules, transmission control module, EML III's control module and the DSC II control module.

A "star coupler connector" was used to link the individual CAN bus leads from the modules into one common connector strip.

The 740i/iL models do not use the star connector. The single DME, AGS and ASC control modules are linked at a splice point in the wiring harness.

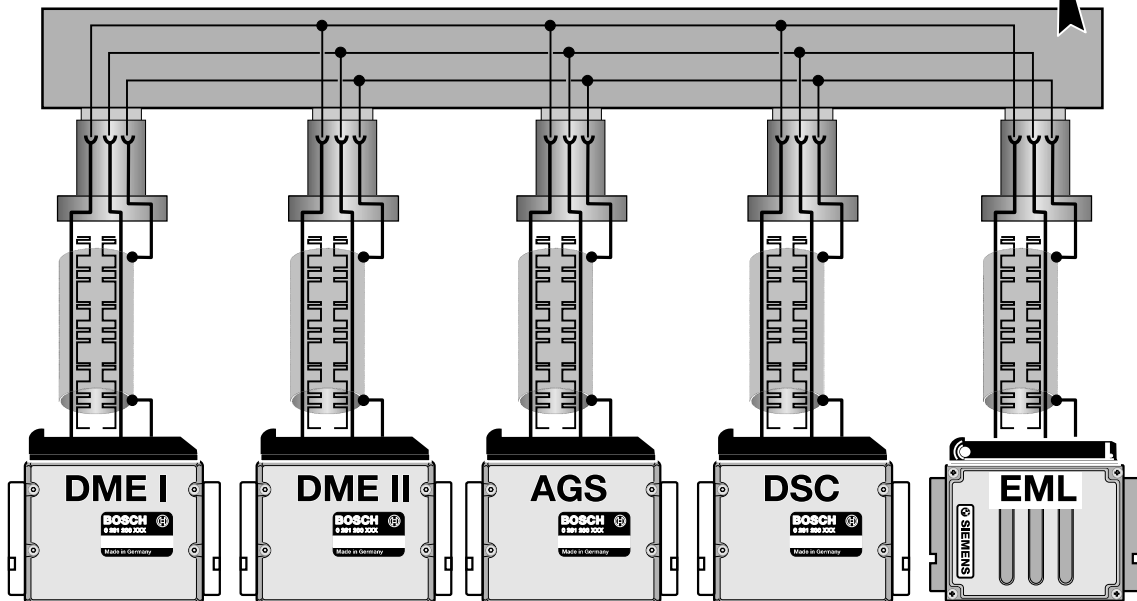
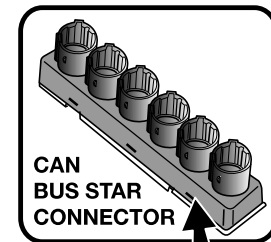

The 1998 model year brought forth the next generation of CAN Bus communicators. The Instrument Cluster and Steering angle sensor of the DSC III system were also linked to the CAN bus to expand the available signalling capabilities.

The Star connector continues to be used for the 750iL but wiring layout (topology) was changed to improve communication integrity in the event of a break or short in another section of the CAN bus. This was accomplished by using the DME control modules as gateways for the EML and AGS control modules.

Additionally, twisted pair wiring is used for the Instrument Cluster and Steering Angle Sensor which provides EMI protection without a separate ground shield.

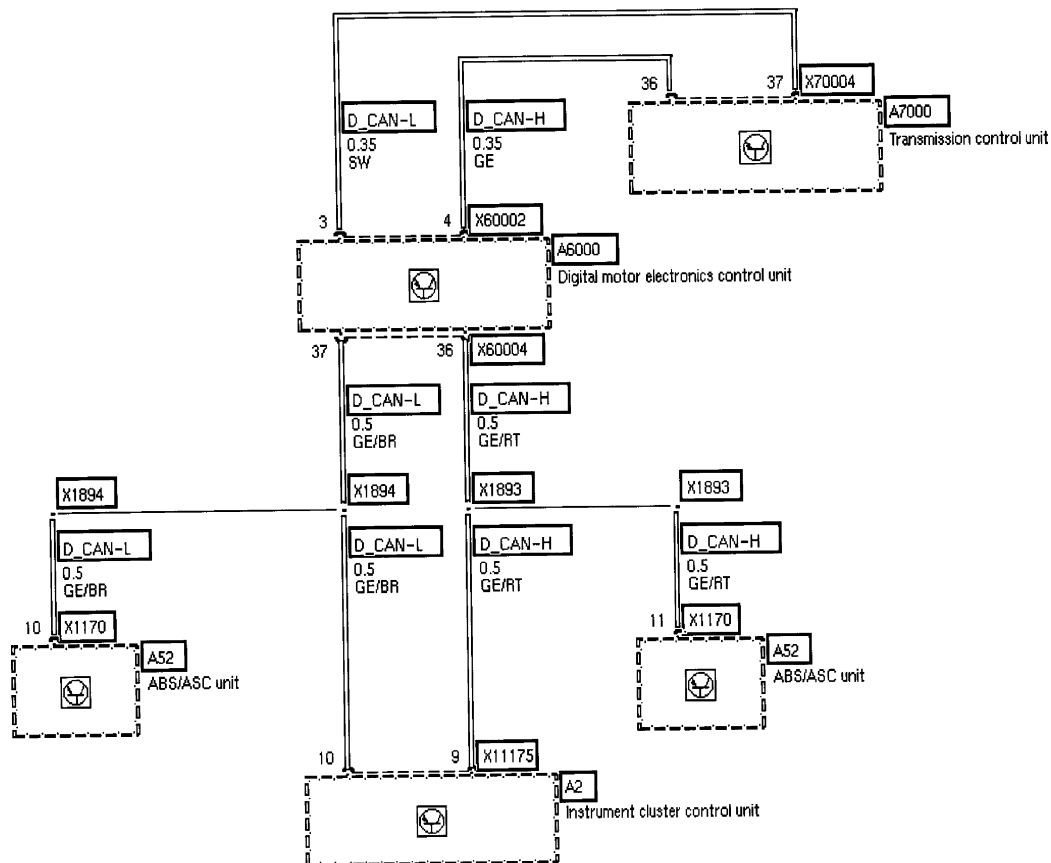

The CAN bus of the 1998 740i/iL and 540i has also changed. The entire CAN bus is twisted pair wiring. The EGS is linked to the DME by a dedicated twisted pair CAN bus with a common twisted pair to all other control modules.

The CAN bus must be considered when diagnosing an engine control system. Faults may manifest due to a breakdown in a segment of the CAN bus with another control module causing a fault to display in the engine control module only due to lack of CAN bus data. When diagnosing a specific system, always refer to the ETM for up-to-date configurations.

CONTROL MODULE VARIANT ENCODING AND PROGRAMMING

The possibility exists that an incorrectly coded or programmed control module will cause system faults and or driveability complaints with no faults found.

This possibility should always be considered (prior to assuming a control module defective) and is easily checked by connecting the DIS/MoDIC and displaying the ID page.

Because of the interaction between the various control units of the Driving Management System, and the various specific model applications, the EML Control Unit is programmed and “coded” for the proper model application (E31, E32/34, E38). Coding is written into the software package of the Control Unit, and identified by the Software Code number. It is also used to identify any updates in the programming.

The proper application of the EML Control Unit can be verified by the:

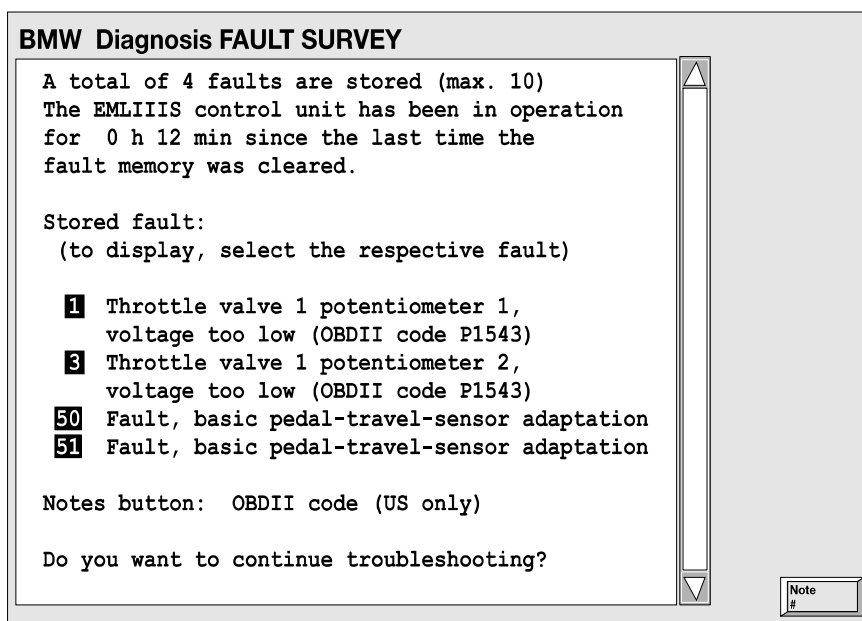

E38 shown

BMW Diagnosis IDENTIFICATION

Electronic engine-power control (EMLIIIS)
12-cylinder engine M73B54 in E31/E38

Part number: 1 429 814

Hardware number: 40
Software number: 07

Diagnosis index: 22
Coding index: 01
Bus index: 32

Production date: 18/97
Supplier: SIEMENS

▽: Siemens Data

Note #

E38 shown

BMW Diagnosis IDENTIFICATION

Electronic engine-power control (EMLIIIS)
12-cylinder engine M73B54 in E31/E38

Siemens Data:

Modification index: a0
Production number: 31672471

Note #

E38 shown

BMW Diagnosis CODING DATA

The following vehicle variant is coded in the EMLIIS control module:

Vehicle variant (computer MC1): 5

E38 M73 AG US 210 (until 9/97)

Vehicle variant (computer MC2): 5

E38 M73 AG US 210 (until 9/97)

Note:

Meaning of the vehicle versions

(model year refers to the vehicle):

Version 2: E31 M73 AG ECE/US 250

Version 3: E38 M73 AG ECE 250 (until 9/97) or

E38 ALPINA D3 SWITCH-TRONIC

Version 4: M73 AG 250 (up to 9/97)

Version 5: E38 M73 AG US 210 (up to 9/97)

Version 6: E38 M73 AG Safety 210 (until 9/97)

Version 9: E31 M73 AG 250 (9/97 to 9/98)

Note
#

E38 shown

BMW Diagnosis CODING DATA

Version 10: E38 M73 AG 210 (9/97 to 9/98)
 Version 16: E38 M73 AG 250 (from 9/98)
 Version 17: E38 M73 AG 210 (from 9/98)
 Otherwise replacement version: E31 HG 210

Note: Variant can only be encoded using program <encoding ZCS>.

With DIS: Back with to identification page, once again, then press buttons <change> - <encoding>; back with <change> - <diagnosis>.

With MoDiC: With back to summary, then select <encoding ZCS>.

Note
#

E38 shown

PROGRAMMABLE CONTROL MODULES: SIEMENS MS42.0

- The ID page provides the part numbers of the control modules. Compare these numbers to what should be in the vehicle by referring to SI 13 02 90. Also, perform a determination process with the DIS/MoDIC for correct part numbers.
- Look into the vehicle history file for possible service action that have been performed on the vehicle.
- If the programming has been performed on the control module recently, consider reprogramming it.

Refer to *Understanding Control Module Coding and Programming* for complete information, procedures and troubleshooting information.

This publication was originally mailed to every Tracs registered Retailer Technician in 1995. This material is also part of BMW's Technical Introductory Course; Technical Systems (ST 050).

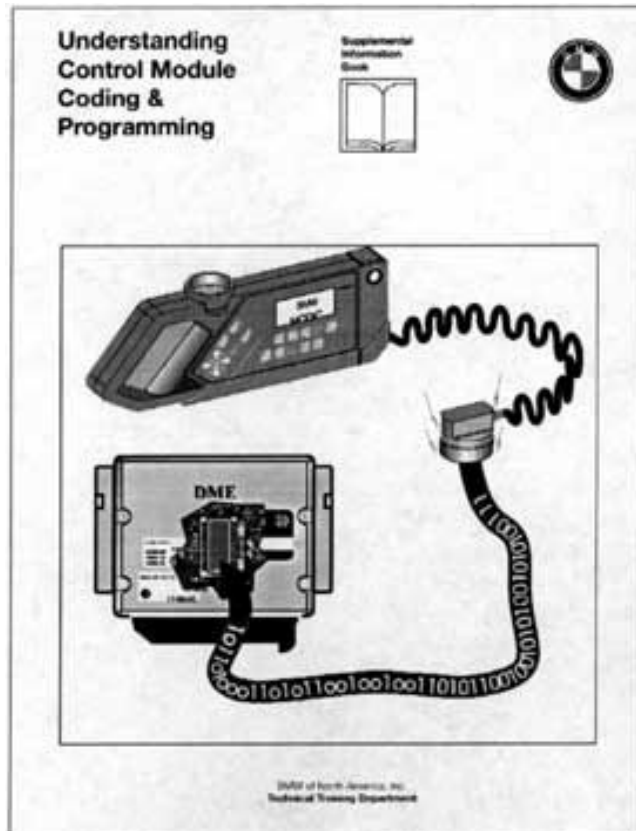

BMW Diagnosis Control unit functions

Control units

DME Motor Electronics MS42

Functions

Identification

- Read fault memory
- Delete fault memory
- Component activation
- Diagnosis requests

Part functions

Messages and results

- Chassis number
- Type approval number (authority number)
- Part number, basic control module
- Part number, programmed control module
- Date of manufacture
- Diagnosis index
- Software index
- Amendment index

WBAAAM3333XFP50013

1430391
1430268
1430298
02.04.98
20 C8
00

E46 shown



Notes on BMW DIAGNOSE-SYSTEM

Defect Code Memory

The component functions and signals listed below are processed or controlled by the DML control unit, but not stored as a defect code in the case of defect:

- LL-signal (sends the "idle" information to the DME)
- VL-signal (sends the "full load" information to the DME)
- A/C switch
- A/C compressor clutch (lock sensor)
- Range selector switch ("P" or "N" position in automatic transmission)
- Clutch switch (manual transmission)
- Brake light switch
- External safety path

The external safety path cannot be read out in the status lists of the BMW DIAGNOSTIC SYSTEM.

Defect Code Priority

The EML control unit stores a maximum of 5 defect codes. When the defect code memory is full, a new defect code with higher priority displaces a lower priority defect code already stored (see ♦♦ # Notes).

Status Monitoring

Since all inputs and outputs and their plausibilities are not covered by the defect code memory of the EML control unit, the status monitoring functions must be used to facilitate troubleshooting.

The nominal values and actual values indicated in the status lists need not necessarily agree exactly. The EML control unit stores a defect code if the deviation between the nominal value and the actual value is outside the permissible range.

For the permissible ranges, refer to the functional description or the troubleshooting description in the BMW DIAGNOSTIC SYSTEM. If the permissible range has been exceeded and the EML control unit has detected this as a defect, the component and its line connection can be checked without complex measurements with the aid of the actual value display.



Abbreviations

ABS	Anti-lock brake system	DKR	Throttle reduction
ASC	Automatic stability control	DKE	Throttle increase
DME	Digital engine electronics	HG	Manual transmission
EGS	Electronic transmission control	ME	Engine intervention
EML	Electronic throttle control	PWG	Pedal position sensor
MSR	Engine drag torque control	Poti	Potentiometer
A	Output	TD	Engine speed signal (once per ignition)
E	Input	TR	Engine speed signal (three times per crankshaft revolution)
DK	EML throttle	TMOT	Engine temperature sensor
DKV	Set throttle value	ti	Injection signal
		LL	Idle signa
		VL	Full load signal
		WK	Torque converter clutch
		ZAB	Ignition fade-out



Pin Assignments

Pin Assignments at the EML 12-cyl. Control Unit Connector X6004

Pin	Type	Description/Function	Connection	Type of signal	Test display	Measurement notes
1	A	5V (not short-circuit-proof)	PWG switch	approx. 5 V	None	
2	A	Ground (electronic ground)	Component ground PWG			
3		Not used				
4	E	DK angle reduction (DKR)	ASC control unit	Square-wave signal	Defect code is stored	◆ M ◆ 14 approx. 100Hz
5	A	Full load signal	DME control unit 1...6. cylinder	approx. 0 V open	ON OFF	
6	A	Idle signal	DME control unit 1...6. cylinder	approx. 0 V open	ON OFF	
7	E	PWG setting	PWG potentiometer	approx. 0.4 V to 4 V	Winkel	
8	E	Road speed signal	Instrument cluster	Square-wave signal	None	◆ M ◆ 14
9	A	5V (not short-circuit-proof)	PWG potentiometer	approx. 5 V	None	
10	A	Ground (electronic ground)	Component ground DK - 7..12. cylinder			
11	A	5V (nicht Kurzschlußfest)	DK potentiometer DK 7..12. cylinder	approx. 5 V	None	
12	A	5V (nicht Kurzschlußfest)	DK potentiometer DK 1..6. cylinder	approx. 5 V	None	

Electronic Throttle Control (EML, 12-Cylinder)



Pin	Type	Description/Function	Connection	Type of signal	Test display	Measurement notes
13	E	Diagnosis	Diagnostic socket RxD			
14	E	Ground (Output ground)	Output ground DK 1...6. cylinder			
15	A	EML warning lamp	Instrument cluster	approx. 0 V	ON	*) With ignition switched
*)	E	Voltage supply for defect code memory		approx. 12 V	None	off
16	A	Drive throttle (DK) actuator	DK actuator DK - 7..12. cylinder	Square-wave signal	Defect code is stored	
17	A	Drive throttle (DK) actuator	DK actuator DK 1...6. cylinder	Square-wave signal	Defect code is stored	
18	E	Voltage supply plus	DME main relay 1...6. cylinder	On-board volt- age	None	
19	E	Ground	Ground point			
20	A	Kick-down signal	EGS control unit	approx. 0 V	ON	
21		Not used		approx. 12 V	OFF	
22	E	DK angle increase (DKE)	ASC control unit	Square-wave signal	Defect code is stored	♦ M ♦ 14 approx. 100Hz
23	A	Drosselklappensignal (DKV)	ASC / EGS	Square-wave signal	Defect code is stored	♦ M ♦ 14 approx. 100Hz
24		Not used				
25	A	5 V (not short-circuit-proof)	DK - 1...6. cylinder (not used)	approx. 5 V		
26	A	Ground (electronic ground)	Component ground DK 1...6. cylinder			



Electronic Throttle Control (EML, 12-Cylinder)

18

04/90

1270.1A-18

1990

Pin	Type	Description/Function	Connection	Type of signal	Test display	Measurement notes
53	E	Brake light switch	Brake light switch	approx. 12 V open	ON OFF	
54		Not used				
55	E/A	Diagnosis	Diagnostic socket TxD			

Adapters

Component	Connector No.	Description	Adapternumber
Control unit	X 6004	55-pole	Connection lead, periphery HWB 81 12 9 428 907
		55-pole	Connection lead, control unit HWB 81 12 9 428 908
		55-pole	Universal adapter HWB 81 12 9 425 091
EML safety path		Safety path testing	EML adapter Cartool 12 7 010



Troubleshooting

Notes

- Relevant safety codes and accident prevention regulations must be observed when carrying out all tests and work on the engine electronic system. Do not touch an EML throttle valve when it is in operation.

Important!

Wherever possible, the battery and the instrument cluster should not be disconnected otherwise all defect codes and teach-in values stored in the EML control unit will be deleted (see ♦♦ # Notes).

Disconnect control unit from the wire harness **only** when the ignition is switched off

Attention! The stage outputs of the EML control unit for the throttle (DK) actuators are not short-circuit-proof. In the same way, the 5 V component supply voltage coming from the EML control unit is not absolutely short-circuit-proof.

Organisation of the Defect Code Pages on the Display Screen

- **Defect location:** The defect can be in the vicinity of the component, the associated wires or in the control unit. The number before the defect code indicates the priority of the defect code (♦♦ # Notes).
- **Type of defect:** Range transgression or illogical (wrong sequence) functions are indicated.
- **Detected at:** Additional defect information on the operating statuses during defect detection (compare values with substitute values). This information can provide an indication relating to plausibility (correct sequence), shorts, breaks and range transgressions.

EML Warning Lamp

After switching on the ignition, EML control unit checks its vital components (safety check) and causes the EML warning lamp to light for approx. 2 seconds. The EML reduces the output if the EML warning lamp cannot be set due to a defect in the lamps or associated wires. The warning lamp continues to light if one of the defects 8 to 22 occurs after the safety check (♦♦ # Notes).

Defect Code Table

♦♦ Defect code memory – stored defect codes

One or several defect codes stored → troubleshooting in accordance with BMW DIAGNOSTIC SYSTEM.

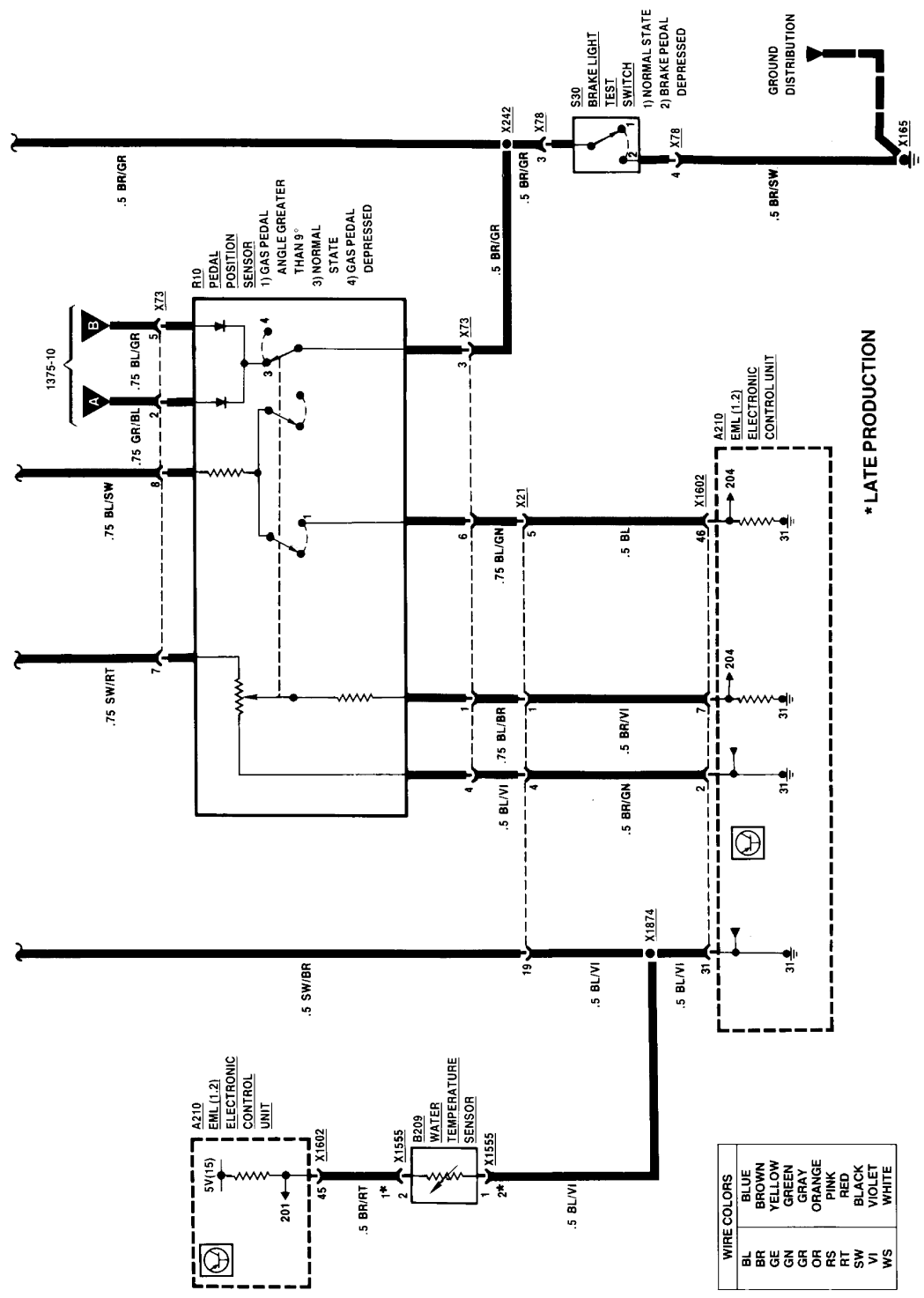

WIRE COLORS	
BL	BLUE
BR	BROWN
GE	YELLOW
GN	GREEN
GR	GRAY
OR	ORANGE
RS	PINK
RT	RED
SW	BLACK
VI	VIOLET
WS	WHITE

ELECTRONIC THROTTLE CONTROL (EML 1.2) 750iL

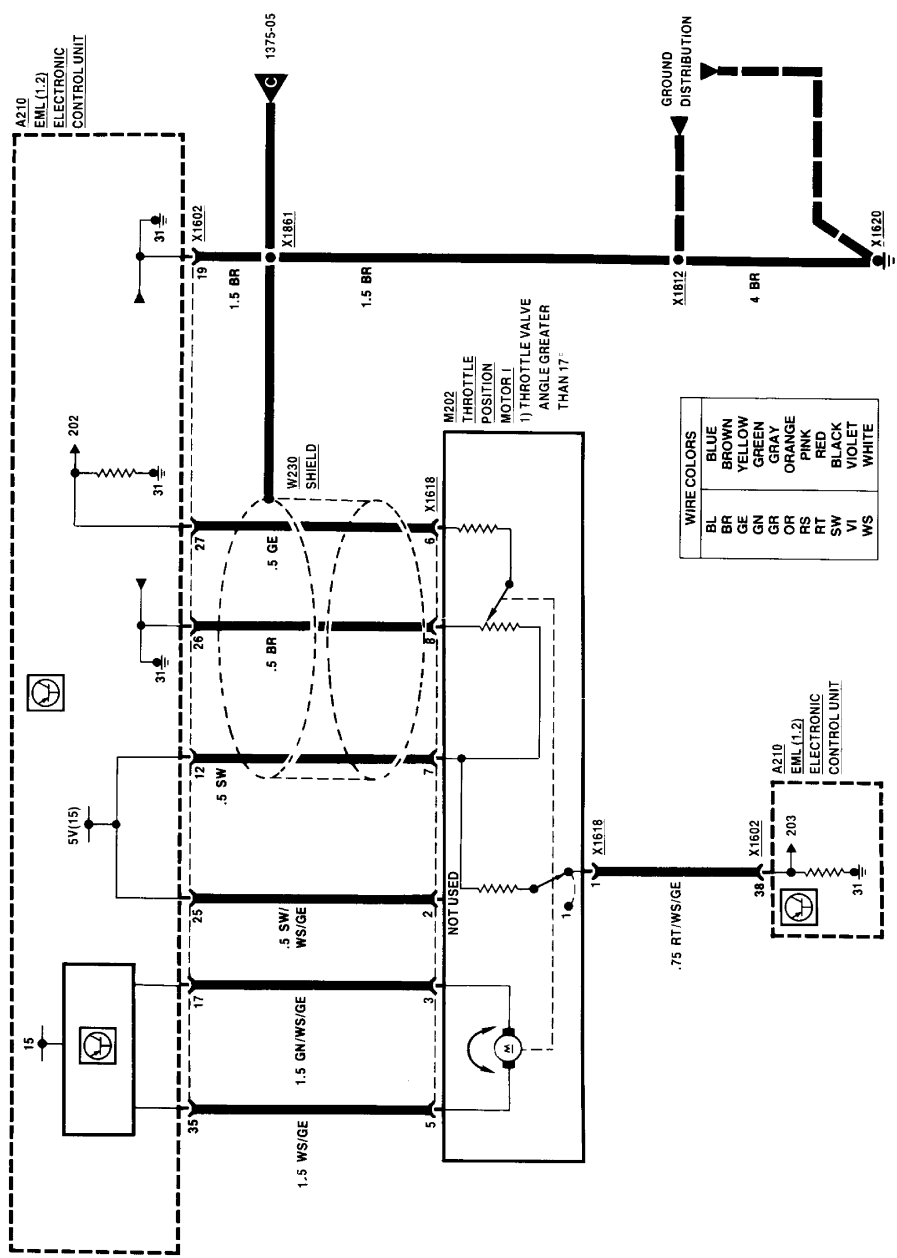

BMW Diagnosis Operation and component selection

Operations

- Drive
- Engine
- Engine electrical system**
- Electronic car immobilization sys
- E box
- Starter
- Alternator
- Fuel system
- Transmission, drive train
- Chassis
- Body
- Components

Engine electrical system

- Engine
- Electronic engine-power control
- Power supply
- OBD plug
- Interfaces, signals
- Sensors**
- Actuator

Components

- Fuel shutoff system (SKA)
- Main switch, cruise control
- Pedal-travel sensor**
- Throttle valve 1 potentiometer (cyls)
- Throttle valve 2 potentiometer (cyls)
- Kickdown switch

Pedal-travel sensor

E46 shown

BMW Diagnosis Test schedule

- **Electronic engine-power control eml**



E38 shown

BMW Diagnosis SELECTION

1 **Fault symptoms**

2 **Function test**

3 **Service functions**

4 **Expert mode**

Note #

E38 shown

BMW Diagnosis FAULT SYMPTOMS

- 3** Engine dies while driving or cannot be started
- 4** Engine suffering from lack of power or poor throttle response
- 5** Cruise-control system operation faulty or not possible
- 6** Engine only runs at idle speed and does not respond to throttle
- 7** Engine running with top-speed regulation
- 8** Idle-speed control not perfect (Idle-actuator operation restricted)
- 9** Engine runs on only one cylinder bank
- 10** Kickdown downshift not possible
- 11** Fault lamp is ON (check Engine or EML warning lamp or CC message "Engine limp-home program")
- 99** None of the fault symptoms indicated is applicable.

Note
#

E38 shown

BMW Diagnosis FAULT SURVEY

A total of 4 faults are stored (max. 10)
The EMLIIS control unit has been in operation
for 0 h 12 min since the last time the
fault memory was cleared.

Stored fault:
(to display, select the respective fault)

- 1** Throttle valve 1 potentiometer 1,
voltage too low (OBDDII code P1543)
- 3** Throttle valve 1 potentiometer 2,
voltage too low (OBDDII code P1543)
- 50** Fault, basic pedal-travel-sensor adaptation
- 51** Fault, basic pedal-travel-sensor adaptation

Notes button: OBDDII code (US only)

Do you want to continue troubleshooting?

Note
#

E38 shown

BMW Diagnosis TEST MODULES

The following test module must be executed:

- 230** Throttle-valve electronics,
wiper voltage of potentiometer 1 too low
- 232** Throttle-valve electronics,
wiper voltage of potentiometer 2 too low

- 284** Basic pedal-travel-sensor adaptation
values

Other general test modules if the test modules related to the fault memory have not led to the fault being eliminated or if no more test modules are displayed:

- 251** Reference to the DME control units

Note
#

E38 shown

BMW Diagnosis TEST MODULES

230 Throttle-valve electronics,
wiper voltage of potentiometer 1 too low

Note:

The fault may not only be throttle valve (TV) 1 but also in throttle valve 2.
For faulty throttle valve x, see fault title in fault memory (Fault 1 or 5)

Instruction:

Check wiper voltage (potentiometer 1) of faulty throttle valve:
- Under the ambient conditions of the fault and
- In the following display
Specified value of potentiometer 1 > 0.20 V
(ignition ON, accelerator pedal at idle speed)

Check:

Note
#

BMW Diagnosis TEST MODULES

Current wiper voltages:
potentiometer 1 in TV1 (TV1-SIG1) 0.0 V
potentiometer 1 in TV2 (TV2-SIG1) 0.4 V

Are all the measured values within the permissible range?

- 1 Yes
- 2 No

Note #

E38 shown

BMW Diagnosis TEST MODULES

230 Throttle-valve electronics,
wiper voltage of potentiometer 1 too low

Note:

The fault may not only be throttle valve (TV) 1 but also in throttle valve 2.
For faulty throttle valve x, see fault title in fault memory (Fault 1 or 5).

Check wires (only when ignition is OFF!) :

- Check all wires for visible damage.
- Check whether plug-in connections (control-unit connectors and connectors on the components) are fitted correctly and have good contact.

Is the wire OK?

- If No: repair wire and/or plug-in connection and check whether fault is stored again.

Note
#

E38 shown

BMW Diagnosis TEST MODULES

-If Yes: continue test module as follows.

Instruction:

If the fault is constantly present or the wiper voltage is currently $< 0.2\text{ V}$, carry out 2 resistance measurements:

- 1** Signal TVx-SIG1 (potentiometer 1) is short-circuited to signal TVx-GND1
- 2** Signal TVx-5V-1 (potentiometer 1) is interrupted

Note:

- When taking measurements: use 88-pin adapter (61 4 410) connect or disconnect only when ignition is OFF!).
- When measuring resistance to terminal 31 or terminal 87: disconnect diagnosis plug!

Note
#

E38 shown

BMW Diagnosis Operation and component selection

Operations

- Drive
- Engine
- Engine electrical system**
- Electronic car immobilization sys
- E box
- Starter
- Alternator
- Fuel system
- Transmission, drive train
- Chassis
- Body
- Components

Engine electrical system

- Engine
- Electronic engine-power control
- Power supply
- OBD plug
- Interfaces, signals
- Sensors**
- Actuator

Components

- Fuel shutoff system (SKA)
- Main switch, cruise control
- Pedal-travel sensor**
- Throttle valve 1 potentiometer (cyls.
- Throttle valve 2 potentiometer (cyls.
- Kickdown switch

Pedal-travel sensor

E46 shown

Pedal position sensor SP

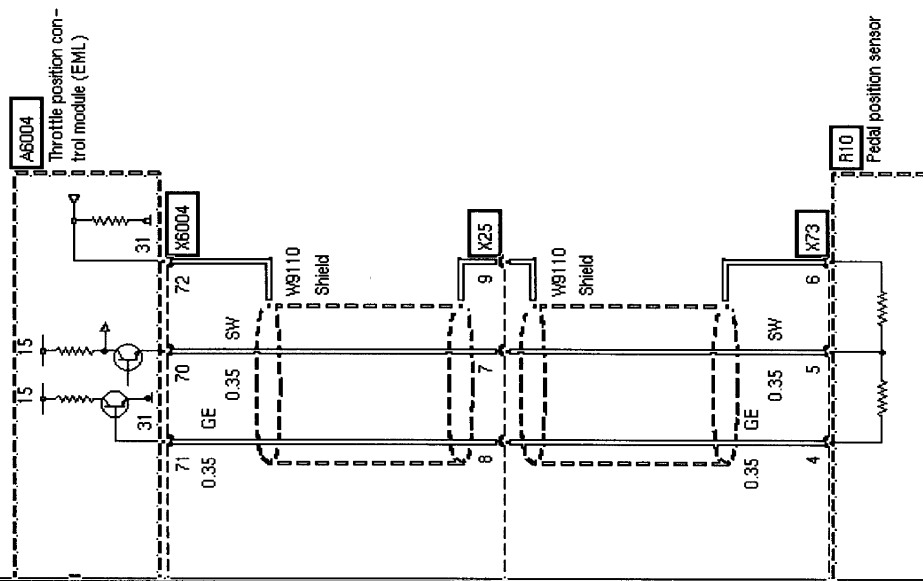

Pedal position sensor (PWG) FB

Pedal position sensor (PWG)

The pedal position sensor in the EMLIIS system is used to record the driver's requirements. For this purpose, a measured signal (signal name PWGx-SIG; x = 1, 2 or 3) proportional to the accelerator pedal angle is generated in a pair of coils in the pedal position sensor (PWG).

3 pedal position sensors are installed in order to ensure in the event of a sensor failing that the driver's requirements are recorded without losses in safety.

The 3 measured signals are transferred via 3 shielded supply lines to the EMLIIS control unit where they are processed in 3 evaluation circuits (so-called angle pulse generator ICs, WIG-ICs).

The valid value range of the accelerator pedal angle is between 0 and 99.6 %.

Basic adaptation of pedal position sensor FB

Basic adaptation of pedal position sensor

In order to compensate for production-related tolerances in the pedal position sensor (PWG) system, the PWG limit stop (idle point and kick-down limit stop) are determined in a basic adaptation-learn mode. For this reason, it is necessary when replacing the EMLIIS control unit or the pedal position sensor to carry out PWG basic adaptation in order to adapt the new tolerances. To ensure this step is carried out, the engine will not accept the throttle system before PWG basic adaptation has been carried out.

The EMLIIS control unit assumes the start status for learn mode when the PWG basic adaptation values are deleted by one of the following conditions:

- A new variant is coded in the EMLIIS control unit; this is only possible with the encoding program "encoding ZCS" via the DIS or ModIC testers.

BMW Diagnosis Control unit functions

Control units	Functions	Part functions
DME Motor Electronics MS42	Identification Read fault memory Delete fault memory Component activation Diagnosis requests	<ul style="list-style-type: none">- Engine speed- Vehicle speed- Coolant temperature, engine- Coolant temperature, radiator outlet- Oil temperature, engine- Intake-air temperature- Signal, driver's-wish sensor 1- Adaptation, driver's-wish sensor 1- Signal, driver's-wish sensor 2- Adaptation, driver's-wish sensor 2- Driver's-wish-sensor angle- Throttle angle- Signal 1, engine throttle- Adaptation 1, engine throttle- Signal 2, engine throttle- Adaptation 2, engine throttle
Messages and results		

BMW Diagnosis Control unit functions

Control units

ZKE Central body electronics
DME Motor Electronics MS42
 EGS Transmission control GS20
 x EWS Electronic immobilizer
 MFL Multi-function steering wheel
 ASC stability control MK20
 IHKA Heater/automatic A/C control
 PDC Park Distance Control
 RAD Radio
 KOM Instrument cluster
 x MRS Multiple Restraint System
 LSZ Lights switching center

Functions

Identification
 Read fault memory
 Delete fault memory
 Component activation
 Diagnosis requests

Part functions

- Oil temperature, engine
 - Intake-air temperature
 = Signal, driver's-wish sensor 1
 = Adaptation, driver's-wish sensor 1
 = Signal, driver's-wish sensor 2
 = Adaptation, driver's-wish sensor 2
 = Driver's-wish-sensor angle
 = Throttle angle
 = Signal 1, engine throttle
 = Adaptation 1, engine throttle
 = Signal 2, engine throttle
 = Adaptation 2, engine throttle
 - Adaptation, coupling spring
 - Voltage, air-mass flow sensor
 - Air mass
 - Load signal

Display

Messages and results

Signal, driver's-wish sensor 1	0.72 V	Adaptation, driver's-wish sensor 1	9.28 %
Signal, driver's-wish sensor 2	0.77 V	Adaptation, driver's-wish sensor 2	9.88 %
Driver's-wish-sensor angle	0 °PW	Throttle-valve angle	0 °DK
Signal 1, engine throttle	0.9 V	Adaptation 1, engine throttle	11.02 %
Signal 2, engine throttle	0.9 V	Adaptation 2, engine throttle	10.83 %

BMW Diagnosis Operation and component selection

<p>Operations</p> <ul style="list-style-type: none"> Complete vehicle Drive Voltage and current control Starter control Electronics box, fan Engine management MS42 Transmission control GS20 Chassis Body Component and signal information Service functions 	<p>Engine management MS42</p> <ul style="list-style-type: none"> Misfire detection Injection Cruise control Pedals Mixture induction A/C-compressor control Knock control Oxygen-sensor control Air supply Engine-speed measurement Engine cooling Camshaft control Suction jet pump Interfaces Secondary-air injection Power supply Control-unit test Tank ventilation Ignition Symptoms 	<p>Components</p> <p>Air supply</p> <p>Engine throttle</p> <ul style="list-style-type: none"> Solenoid valve, intake manifold (DIS) Idle actuator Air-mass flow sensor Intake-air temperature
<p>Engine throttle</p>		

BMW Diagnosis Fault symptom selection

Vehicle subsystem:

Perception:

Drive
Chassis
Display/information systems
Theft systems

Transmission
Engine
Cruise control

Starting characterist
Idling
Vehicle handling
Cruise control
Cooling
Control module

Malfunction

Engine - Cruise control - Malfunction

Contents of defect code memories (not selectable or deletable)

Accepted symptoms
Engine - Cruise control - Malfunction

Transfer

Delete

BMW Diagnosis Test schedule
DIS test schedule
Engine - Cruise control - Malfunction
P Interface, multi-function steering wheel B1214_MOMFL
Own test schedule
? Engine throttle B1214_MOMDK

BMW Diagnosis Test Information

Throttle valve

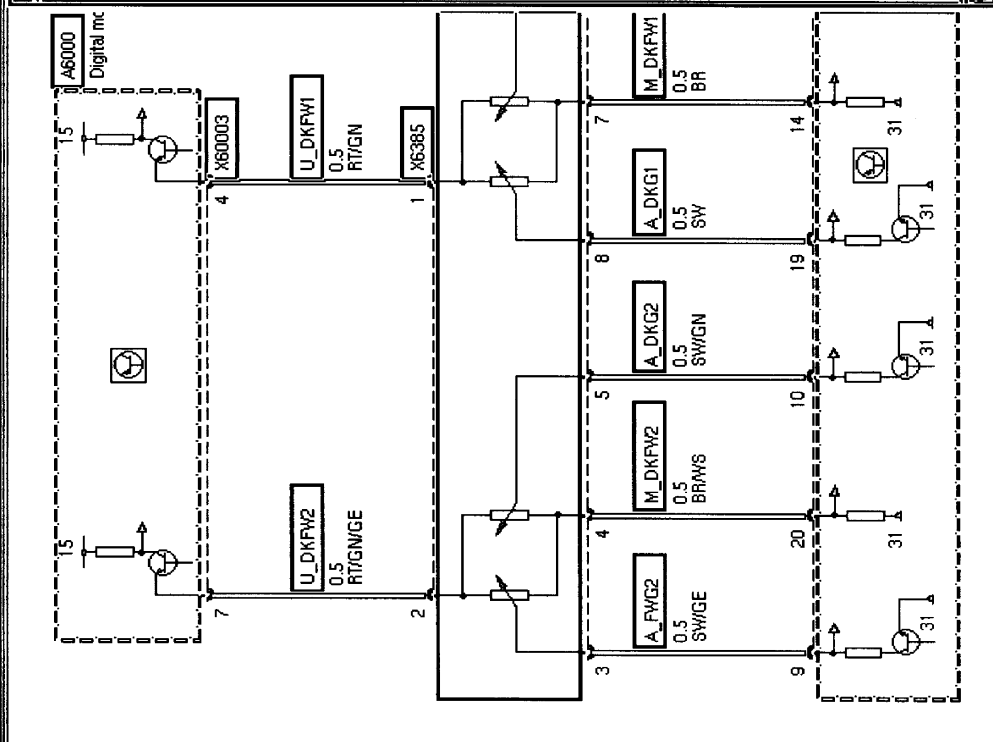

Motor-Driven Throttle Valve

With the aid of the motor-driven throttle valve, the throttle valve can be opened independent of the accelerator pedal position.

The motor-driven throttle valve in the M52 and M54 differs from electronic engine management (EML) in following points:

- No potentiometer on accelerator pedal but rather a double potentiometer on the pulley of the motor-driven throttle valve
- There is a bowden cable fitted between the accelerator pedal and motor-driven throttle valve which is also used for emergency operation purposes.

B1214 MOMDK/Message_04

No fault can currently be found in the tested assembly.